

FORGOTTEN REALMS

Official Game Accessory

INSIDE RAVENS BLUFF,
THE LIVING CITY

K. WARD

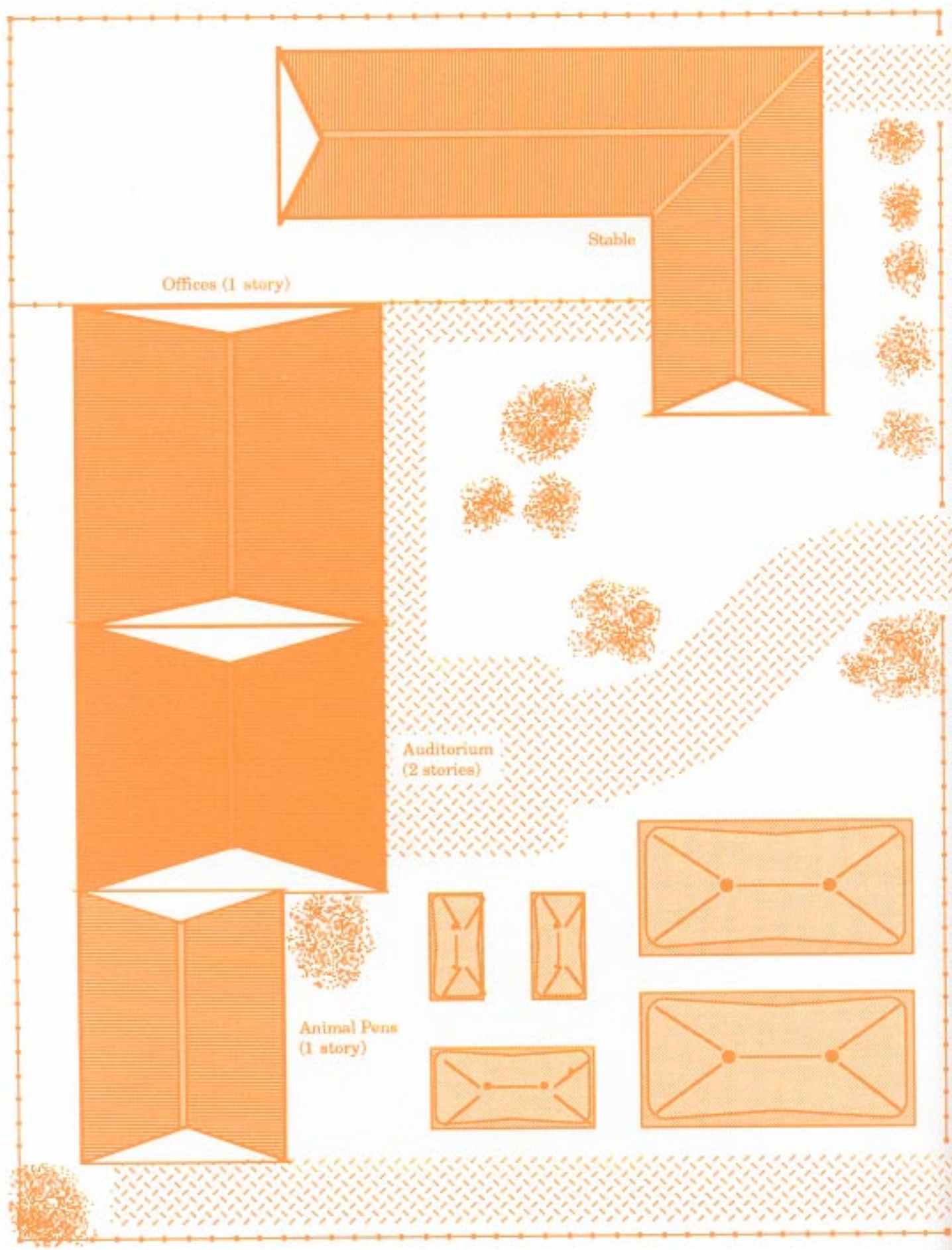

Stable

Offices (1 story)



Auditorium (2 stories)

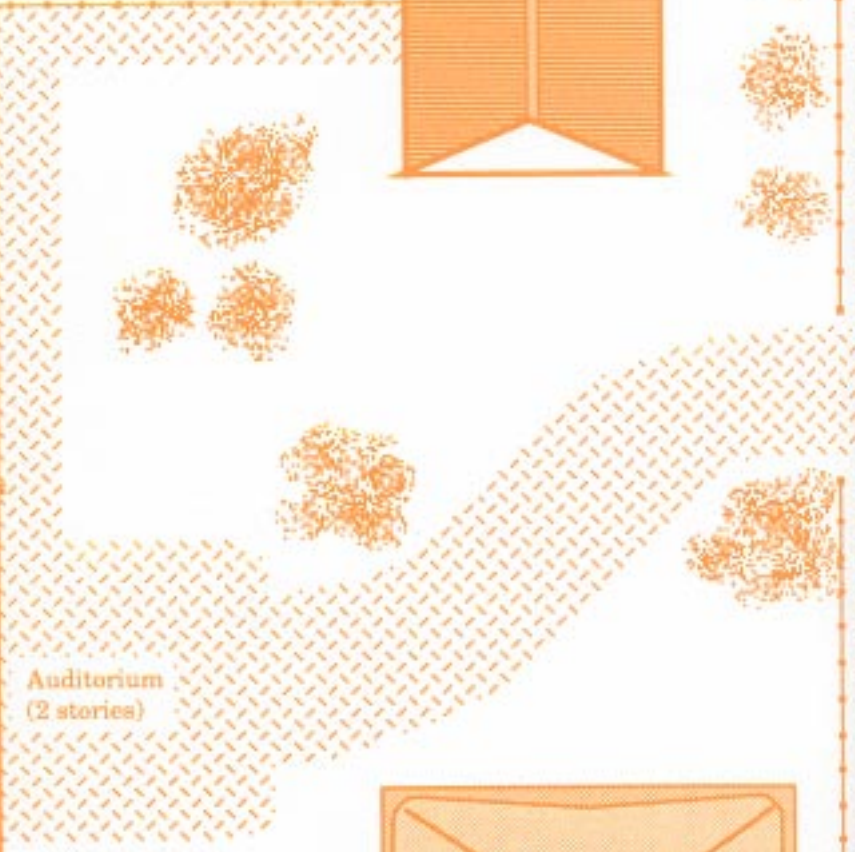

Animal Pens (1 story)

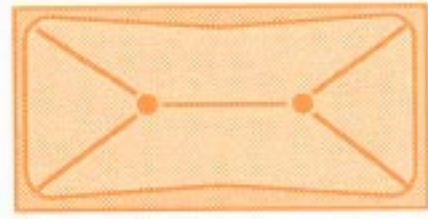
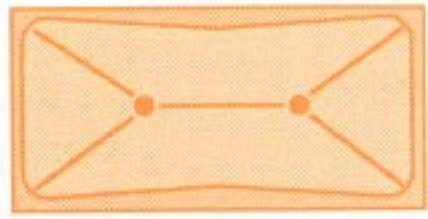

INSIDE RAVENS BLUFF, THE LIVING CITY

| | |
|--|----|
| The Mooney & Sons Circus | |
| Welcome to the Circus. | 2 |
| Circus Personalities – by Jean Rabe & Skip Williams | |
| Jack Mooney | 3 |
| Lockwood & Edan Mooney. | 4 |
| Silva Elkwood | 5 |
| Midway Games | |
| Collar the Beast – by Larry “Mac” Macabee | 6 |
| Dangar’s Dunk Tank – by Jim Lowder | 7 |
| Pick A Prize – by David Carl Argall | 8 |
| Arthur’s Archery – by Roger Anderson. | 9 |
| Midway Rides | |
| For the Byrdds – by Rob Nicholls | 11 |
| Tumble Tower – by Tim Beach | 13 |
| Whitewater – by Tim Beach. | 14 |
| Flight Into the Dragon’s Jaws – by Roger Anderson | 16 |
| Leaping Lizards – by Larry “Mac” Macabee | 17 |
| Jaws of Death – by Tim Beach | 19 |
| Tarrantuttle’s Merry-Go-Round – by Wes Nicholson | 21 |
| Vendors | |
| Fortune’s Lady – by Michael Tracey | 22 |
| Terrific Ts – by Tim Beach | 25 |
| Caricatures – by Tim Beach | 26 |
| Glitz & Klax’s Potions & Elixers – by Joe Littrel | 27 |
| Portrait Balls – by Tim Beach | 29 |
| Starbright the Knight – by Roger Anderson. | 30 |
| Living Tattoos – by Holly Riggenbach & Thayathas Schwartz. | 33 |
| Piper’s Song Pest Control – by Ben Pierce | 35 |
| The Sandmen – by Joe Littrel | 37 |
| The Big Top | |
| Isbeau Navarone – by John Kroech | 39 |
| Doagar the Beholder Tamer – by Tim Beach, | 41 |
| Bjorn the Bear Wrestler – by Sean Scott | 42 |
| The Talking and Singing Owlbear – by Ralph Manson | 44 |
| Clowns – by Jay Tummelson | 46 |
| The Flying Ringken – by Harold Johnson & Bob Bigalow | 48 |
| Using the Circus. | 50 |
| Inside Ravens Bluff | |
| Ravens Bluff and Environs – by Ed Greenwood. | 51 |
| Party on Embassy Row – by Wes Nicholson. | 56 |
| The Vulture – by Skip Williams & Jean Rabe | 59 |
| Leaf In Root – by Allen J. Block | 60 |
| Living City Writers Guidelines. | 63 |

Credits

| | |
|---|---|
| Compiled by: Jean Rabe Editors: Skip Williams & Jean Rabe Cover Art: Kevin Ward | Interior Art: Jim Holloway Cartography: Dave Conant Keylining: Paul Hanchette |
|---|---|

Dedication: To present and future members of the RPGA Network; and to their creativity and enthusiasm, which make this and future Living City products possible.

ADVANCED DUNGEONS & DRAGONS, AD&D, FORGOTTEN RELAMS, and RAVENS BLUFF are trademarks owned by TSR, Inc.

POLYHEDRON, ROLE-PLAYING GAME ASSOCIATION, and RPGA are service marks owned by TSR, inc. ©1990 TSR, Inc. All Rights Reserved.



The Jack Mooney & Sons Circus

Hurry, hurry, step right up to the grandest, most glorious circus in Faerun!

The Jack Mooney & Sons Circus, which winters in Ravens Bluff, The Living City, travels throughout the Realms, bringing excitement, thrills, and fun to all races and all ages.

Meet Jack Mooney, the circus proprietor and ringmaster. The dashing ranger promises a circus unlike any other and guarantees a Big Top show that will be enjoyed by all.

Stroll down the midway and test your character's luck at one of the dozens of games of chance. Try *Pick A Prize*, where a tug on a string could yield a treasure. Take a toss at *Collar the Beast*, where the most dextrous succeed.

Stop at various vendor wagons where your character can have his portrait painted on a tunic, acquire a moving tattoo, test his skill at archery, or attempt to dunk an insulting half-orc.

And there's more, because the fun never stops at the circus. Ride on the *Whitewater*, where the watery turns spell danger. Jump on *The Leaping Lizard*, and see if you're man or woman enough to hang on. Take a *Flight Into The Dragon's Jaws*. Or relax on *Tarontuttle's Merry-Go-Round*.

When the sun begins to set head over to the Big Top where the action is just beginning. Decked out in his ringmaster garb, Jack Mooney introduces *The Talking And Singing Owlbear*, *Doagar The Beholder Tamer*, a cavorting clown duo, and more.

The characters who populate the circus will serve as colorful NPCs in any FORGOTTEN REALMS™ campaign world. They – and the great circus itself – can provide many adventures.

The circus, like the Living City, is ever-changing and will continue to grow. More circus acts, games, vendors, personalities, and adventures will appear in the pages of the POLYHEDRON™ Newszine. If you want to add to the circus follow the writers guidelines at the end of this module.

There is no admission fee to enter the circus grounds. Prices at games, rides, and vendor wagons range from one copper piece to many gold pieces.

Admission into the Big Top show is one copper piece for children and three copper pieces for adults. Family passes for one silver piece can be purchased in many cities. Sometimes the circus puts on special shows, spotlighting unusual acts that are only with the circus temporarily. These acts bring up the price of admission.

The Jack Mooney & Sons Circus could charge much more for its Big Top show, but the ranger and his circus family want to keep the price down so almost everyone can attend. They even look the other way when urchins in tattered clothes wriggle under the circus tent flaps to sneak a peak at the acts inside. Some believe Jack Mooney makes sure the tent isn't staked too tightly to the ground to prevent this sort of activity.

So join us now, the show's about to start.

Circus Personalities

Jack Mooney

12th Level Male Human Ranger

STR: 17

INT: 17

WIS: 15

DEX: 12

CON: 16

CHR: 17

COM: 14

AC Normal: -2

AC Rear: -2

Hit Points: 91

Alignment: Chaotic Good

Languages: Common, Elvish, Gnomish, Halfling, Dwarvish, Brownie, Centaur, Circus Jargon

Weapon Proficiencies: Long sword, lasso, dagger, long bow, spear, javelin

Nonweapon Proficiencies: Animal lore (17), animal handling (14), animal training, horses (15), animal training, great cats (15), animal training, elephants (15), riding, land-based (18), gaming (17), tracking (19)

Ranger Abilities: Hide in shadows, 77%; Move silently, 94%

Spells Memorized: Jack carries the following spells daily: *Animal friendship*, *locate animals or plants*, *charm person or mammal*, *speak with animals*, and *hold animal*

Magic Items: *Bracers of defense* AC 0, *cloak of protection* +2, *dagger* +3, *dagger* +1, *long sword of dancing*, *boots of elvenkind*, *ring of sustenance*, *ring of warmth*, *pouch of accessibility*, *stone of good luck*

Followers: Raynock, a tiger: AL N; AC 6; MV 12; HD 5+5; hp 33; THAC0 15; #AT 3; D 2-5/2-5/1-10; SA Rear claws for 2d4 each; SD Surprised only on a 1; S L (7' long). Stray, a leopard: AL N; AC 6; MV 15; HD 3+2; hp 18; THAC0 17; #AT 3; D 1-3/1-3/1-6; SA Rear claws for 1-4 each; SD Surprised only on a 1; S M (4' long). Calliope, a cheetah: AL N; AC 5; MV 15, sprint 45; HD 3; hp 20; #AT 3; 1-2/1-2/1-8; SA Rear claws 1-2 each; SD Surprised only on a 1; S M (4' long)

Appearance: The renowned circus owner is 6' tall, has a well-muscled frame, and keeps his dark brown hair, which is graying at the temples, short and always styled. Jack is physically 45 years old, although he actually has lived 60 years.

Potions of longevity he drank more than a decade ago renewed his body and increased his vitality.

Jack's skin is tanned and weathered because of the decades he spent outdoors as a ranger and later as a circus owner. The sun has added to the numerous deep wrinkles around his blue-flecked black eyes. The hard circus life has kept Jack in excellent physical shape, and his appearance, coupled with his overall rugged good looks, draws the admiration of human and demi-human women in every town the circus plays in. When traveling or when wintering in Ravens Bluff, he is often seen in the company of one or more of his great cat followers which he acquired during an adventure in the jungles of Chut.

Background: Jack is usually a happy-go-lucky man and is cheerful to his employees, who he considers part of his family. He always has a kind word to say to all of the workers, and he is careful to see that the circus operation remains safe so no harm will befall them. His pleasant nature is because of his work – being able to own a respectable business and at the same time travel wherever he pleases. His business is also responsible for his touch of immaturity, and he continues to hold his circus in a childlike wonder. Jack's sons speculate that he never will grow up. Jack's daughter *knows* he never will.

Jack is a native of Daggerdale. Like many of the people who work at his circus, he ran away from home while he was in his early teens. With dreams of becoming a wealthy and famous adventurer to speed him along, he found a ranger to study under and spent the next few years traveling throughout The Dales, Cormyr, and along The Sword Coast. During Jack's travels he fell in love with a beautiful gold elf named Sylvana; he was 17 at the time, and he never bothered to ask how old she was. He tried to settle down with her in a gold elf community – where he was the only human. However, after two unhappy years he realized he was not the kind of man who could live in one place for an extended amount of time. The brief marriage resulted in a daughter, who was given to Jack when he left the community. Sylvana decided it would be difficult for a half-elven child to fit in with a wholly elven community.

Jack could not pronounce his daughter's elvish name, so he began to call her Silva in memory of his first wife, and he resumed his travels throughout the Forgotten Realms. Adventuring with an infant proved difficult, and Jack often left her at various goodly-aligned temples and

with trusted friends.

As Silva grew older he allowed her to join him on some of his jaunts. But his self-appointed missions continued to become increasingly hazardous, and he eventually left Silva at the Temple of Chauntea in Waterdeep. She was 12, but appeared much younger because of her elvish heritage. The clerics welcomed her as an acolyte – after admonishing Jack for abandoning the duties of parenthood. Jack was 30 years old at the time, and the clerics – and Jack – knew the ranger would be quite a bit older by the time he found his way back to the temple.

Jack spent the next two years exploring the lands between The High Moor and Calimport. He celebrated his 32nd birthday in a raucous tavern in Zazesspur, where the ale flowed as quickly as the river on the town's southern edge. Ever a gambler, Jack found himself in a game of chance with roustabouts from the Full Moon Traveling Circus, which was playing in town. Jack was winning heavily, and the circus owner, who had imbibed more than Jack, stepped in to keep the ranger from cleaning out his hired help. The evening wore on, and by the time Jack left the sun was coming up and he was the proud, but slightly confused, owner of the Full Moon Traveling Circus.

The circus was in financial straits, and Jack considered it a challenge to make it successful. There was a high turnover in help the first year under his ownership, as many of the employees favored the previous ringmaster. But Jack enjoyed the company of the circus people, who he considered much like himself – the type of people not inclined to let grass grow under their feet. Eventually they accepted him, the operation began to click, unusual acts were added, the midway grew, and the Jack Mooney Circus became a welcome visitor to towns in the Realms. Gold started pouring in, and a contented Jack began to look around for female companionship. He married a tightrope walker who was 10 years his junior and scheduled a week-long stint in Waterdeep, where he planned to pick up his daughter Silva.

Silva, however, had become a cleric of Chauntea and had no desire to leave the temple for the circus life. Jack was heartbroken. He blamed himself for neglecting Silva and pushing her into clerical studies. To cure his depression, he threw the circus into a grueling schedule that took them across the country and eventually to Ravens Bluff, The Living City. Jack's two

Circus Personalities

sons were born several years apart in the city, where the circus had begun to make its winter headquarters.

Jack's second wife succumbed to the plague that swept the Living City waterfront many years ago. The ranger, remembering his mistake with Silva, decided to raise his sons – Lockwood and Edan – on his own.

The circus continued to flourish over the next decade and expanded its performance circuit. During one performance in Iriaebor a few years ago, Jack was reunited with his daughter, Silva, who tearfully told him that her husband died and she had nowhere to go. Jack begged her to join him in the operation of the circus, which was now called the Mooney & Sons Circus, and she happily accepted. Jack began to lavish attention on her to make up for his poor behavior as a parent, and offered to put her name on the circus banner. Silva told him she wanted to remain in the background and declined. However, Jack knows that someday she will take her rightful place in the circus' management, as he has stated in his will that she receive 50% ownership of the circus.

Jack now considers himself settled down, even though he continues to plot circuits for circus performances. Despite his love of traveling, he enjoys the few months each year he spends in Ravens Bluff, and he revels in the attention the city officials give him. He feels the respect is his due because the circus is one of the largest employers in the city. Frequently it even hires adventurers to capture exotic animals or to act as guards when it travels in dangerous lands.

Under Jack's management the circus continues to grow. He and his sons continually look for new acts to put under the Big Top and new rides, attractions, and games to add to the midway. Jack frequently adds unnecessary personnel to the circus, too, as he is loathe to turn away orphans, runaways, and the misfortunate.

Jack acts as the circus ringmaster. He claims the position keeps him involved in every aspect of the circus and keeps him in close contact with the circus workers. While this is true, Jack's prime motivation for being ringmaster is the attention. The ranger basks in the spotlight and the cheers of crowds.

Lockwood

Male Human Ranger/Enchanter Level 4/5

STR: 16

INT: 17

WIS: 16

DEX: 12

CON: 16

CHA: 16

AC Normal: 3

AC Rear: 5

Hit Points: 31

Alignment: Neutral Good

Languages: Common, Elvish, Gnomish, Halfling, Dwarvish, Brownie, Centaur, Circus Jargon

Spells/Day: 4 2 1 plus one enchantment/charm per spell level

Weapon Proficiencies: Long sword, dagger, spear, long bow, lasso

Nonweapon Proficiencies: Tracking (17), animal lore (17), riding, land (19), herbalism (17), direction sense (17)

Ranger Abilities: Hide in Shadows, 25%; Move Silently, 33%

Magic Items: *Long sword +1, bracers of defense AC 5, boots of speed, wand of illumination (31 charges)*

Spell Books

Level 1 Spells

| | |
|----------------------|-----------------------------|
| <i>Charm Person*</i> | <i>Can trip</i> |
| <i>Sleep*</i> | <i>Taunt*</i> |
| <i>Read Magic</i> | <i>Protection From Evil</i> |

Level 2 Spells

| | |
|----------------------------------|----------------|
| <i>Forget*</i> | <i>Scare*</i> |
| <i>Ray of Enfeeblement*</i> | <i>Knock</i> |
| <i>Protection From Cantrips*</i> | <i>Shatter</i> |

Level 3 Spells

| | |
|---------------------|----------------------|
| <i>Suggestion*</i> | <i>Hold Person*</i> |
| <i>Dispel Magic</i> | <i>Clairaudience</i> |

* Spell usually memorized daily

Appearance: Lockwood is tall, pale, and thin – 6'1" and 160 pounds. He has light brown hair, and wears it shoulder length, cut straight across at the neck and forehead. Lockwood wears simple, functional

clothes that often are dusty from circus work or spattered with wax from his late-night studies. He is 27 years old.

Background: Lockwood was born in Ravens Bluff just after the end of a successful circus season. He grew up as a circus brat, spoiled by his father and by every circus employee who was partial to children, or astute enough to be especially nice to the boss's kid. A few employees, and Lockwood's mother, were too wrapped up in their own lives to pay him much attention. The birth of Lockwood's brother, Edan, and his mother's death two years later worked big changes in the young man's life. Suddenly, he no longer was everybody's darling, and he no longer was free to do what he pleased – now he found himself co-responsible with his father for little Edan.

Lockwood has intense emotions, usually kept tightly in check, and a strong sense of responsibility. At first, he decided to follow in his father's footsteps and become a ranger. However, he felt a need to find something to challenge his mind as he got older. When he badly wrenched his shoulder while helping some roustabouts literally hold things together during a windstorm, he decided to study magic. Years of working with temperamental performers and sophisticated customers taught him the value of magical persuasion, and led him to choose enchantments as a specialty.

In his younger years Lockwood was as hearty and tanned as his father, but more recently he has adopted an austere lifestyle that is reflected in his complexion and frame.

Though he regards the circus employees as family, just as his father and siblings do, he recently has begun to feel that all the effort the staff puts into the circus is a waste of talent. He is certain there are better things to do than entertaining crowds of thrill seekers and providing mostly honest livings to con artists like Lucien Shandor and Eadwyn Wylfora. When the circus is on the road, Lockwood restlessly patrols the grounds, trying to avert trouble and rushing to the site of any problem or disturbance. When the circus winters, however, Lockwood leaves to go adventuring, returning each spring to help prepare for the next season.

Circus Personalities

Edan

5th Level Male Human Fighter

STR: 17
INT: 16
WIS: 15
DEX: 15
CON: 15
CHA: 17

AC Normal: 2

AC Rear: 3

Hit Points: 34

Alignment: Chaotic Good

Languages: Common, Elvish, Gnomish, Halfling, Dwarvish, Brownie, Circus Jargon

Weapon Proficiencies: Long sword (specialist), dagger, lasso, whip

Nonweapon Proficiencies: Tracking (15), etiquette (17), riding, land (16)

Magic Items: *Long sword +1, elven chain mail +2, gloves of missile snaring*

Appearance: The 20-year-old Edan looks just like his older brother, only better. His light brown hair is always smartly trimmed and brushed; his clothing is clean and natty. His skin is well-tanned from the open-air life.

Background: Edan was born in Ravens Bluff one spring just before the circus was ready to hit the road for another season. Like his brother before him, he was the circus darling until he grew too old to fill the role. Unlike his brother, however, he takes pains to be as friendly as possible (or practical) with everybody on the grounds, from the roustabouts to the customers. He admires his father and older brother, but feels that he has found his own way of doing things. He firmly believes he is a better fighter than his brother and is sure that he could beat Lockwood in a fight – if it weren't for Lockwood's magic he certainly could.

Edan is a natural politician and looks forward to the day when his father retires and leaves the circus to himself and his siblings. He assumes each child will receive equal ownership and that he'll really be the person who runs things. When he learns his father's real plans for bequeathing the circus he'll get a nasty shock. Although he secretly resents Lockwood's view of the circus as something trivial, he also is secretly overjoyed that his brother might lose interest in running it. He never misses a chance to make

Lockwood feel the circus can get along without him.

Edan usually can be found near the biggest crowd of people. He helps man the front gate when there is a rush on admissions (this varies with the time and locale), and always is present in the Big Top for the main show. There he assists his father, helps the roustabouts and performers, and even does a little announcing.

Silva Elkwood

6th Level Female Half Elf Cleric

STR: 10

INT: 18

WIS: 18

DEX: 12

CON: 11

CHR: 17

COM: 15

AC Normal: 7

AC Rear: 7

Hit Points: 24

Alignment: Neutral Good

Languages: Common, Elvish, Gnomish, Halfling, Dwarvish, Orcish, Goblin, Gnoll, Circus Jargon

Weapon Proficiencies: Staff, mace, hammer

Nonweapon Proficiencies: Astrology (18), reading/writing (19), ancient languages (18)

Magic Items: *Ring of protection +2, cloak of protection +1, staff +1, periapt of proof against poison*

Spells/day: 5 5 3 As a cleric of Chauntea, Silva has major access to the spheres of All, Healing, Plant, Sun, and Weather, and minor access to the spheres of Divination and Protection.

Spells Memorized: With few exceptions, Silva usually memorizes the following spells each day: *cure light wounds (x3), detect magic (x2), resist fire/resist cold, augury, know alignment, speak with animals (x2), plant growth, continual light, and starshine*

Appearance: Silva is 42 years old, is 5'2" tall, has honey-blond hair, and blue-flecked black eyes. Her elvish heritage is not always apparent, as she wears her long hair loose about her face, inadvertently concealing her slim facial features and her slightly pointed ears. She dresses in dark reds, oranges, and brown; she avoids colorful clothes that would draw attention to her.

Background: Silva grew up resenting her father because he left her with strangers and eventually with the temple of Chauntea. She swore to make a life for herself and was quick to rise in the ranks of Chauntea clerics; she spent most of her time traveling to spread the word of Chauntea. During a stint at the temple in Waterdeep, however, she fell in love with a human worker at the temple, and the two were married in a simple ceremony.

Silva attempted to settle down, but after two years she discovered that she couldn't remain in one place for any great amount of time. Her husband didn't understand and refused to let her travel. One night in anger she ran away from Waterdeep and her marriage, begging her husband in a note to not follow her. She began to travel throughout the realms, and by coincidence eventually ran into her father during a performance of the circus.

Silva still resented him, but she needed a place to stay, and the traveling circus intrigued her. She told her father her husband died, and Jack Mooney was grateful to take her in. He spent the next several months lavishing attention and affection on her. His cheerfulness eroded away her bad feelings, and she grew to care for her father and the circus.

Silva took to her half-brothers quickly, and to the rest of the circus employees. She is liked by all, and a few of the male roustabouts hope to become more than friends with her.

Silva continues to worship Chauntea and holds regular weekly services for the circus workers she has converted to Chauntea's faith. She is quick to use her clerical abilities to help any of the circus workers, particularly those hurt while practicing for their Big Top acts. Occasionally she is called upon to cast *detect magic* during a performance to demonstrate to the audience that the circus is on the up and up and no illusions are used in the Big Top acts.

Silva plans to stay with the circus indefinitely. She has no desire to become involved with any of the circus workers; one bad relationship was enough for her. However, she occasionally flirts because she enjoys the attention.

Midway Games

Collar The Beast

Collar The Beast is one of the oldest attractions at the Jack Mooney & Sons Circus, as evident by the chipped and fading paint on the wooden rails that ring it. It sits in the middle of the midway and continues to draw crowds, despite the newer and flashier games springing up next to it.

The object of the game is to throw rings around the necks of clay statues designed to look like monsters.

To successfully collar a beast, the participant must hit AC 0; THACO is determined as for normal missile attacks and includes any Dexterity bonuses.

To play, a participant pays one copper piece and receives three rings to throw at the statues. He or she receives a prize token for each ring which circles a monster's neck. Tokens can be exchanged for prizes.

1 Token – Worthless trinkets: such as strung beads, glass gems, pieces of candy, a paper flower

2 Tokens – Items worth one to five copper pieces: such as small vases, wooden dolls, wooden whistles, bouquets of paper flowers, coupons for cotton candy, small sack of fruit

3 Tokens – Items worth 1 silver piece: such as colored chalk sets, small stuffed animals, handkerchiefs, small pieces of pottery, candied fruit, hair ornaments, leather bracelets

5 Tokens – Items worth two to five silver pieces: such as scarves, large stuffed animals, bags of taffy, braided rugs, colorful caps, belts, cloth dolls, bags of marbles, bright sashes, mittens

10 Tokens – Items worth one gold piece: such as leather gloves, decorative metal pins, cotton vests embroidered with "I Collared The Beast," coupons for a meal at Embrol Sludge's Eatery and Shell Shoppe, pound of assorted nuts, bells, large belt pouches, small wooden chests (empty, of course), scented sealing wax, set of quills, wooden and metal pull-toys, cloth dolls with carved wooden faces, box of imported candy

A sign at the booth states a player cannot win more than eight 10-token prizes a day.

The game's proprietor, Lucien "Lucky" Shandor, doesn't like to give away the big prizes because it cuts down on his profits. He watches the players carefully, and if a player hits with all three rings in one set, Lucky will attempt to switch rings, giving

the player a set which has a slightly smaller inside diameter. Lucky also attempts to switch rings when a player accumulates five tokens. His chance of switching the rings is 100% minus the player's intelligence rating.

If Lucky successfully switches the rings, the player must then hit AC -2 to ring a statue. A player with these smaller rings has a cumulative chance of 5% per set after the first to notice a difference (maximum of 25% chance). If a player hits after the rings have been switched, Lucky's next tactic is to tilt the table. This changes the odds; a player with a regular ring needs to hit AC -2, a player with a smaller diameter ring needs to hit AC -4. Lucky's chance of tilting the table without being spotted is 100% minus the player's intelligence rating. (A check should be made for each player at the game.)

If Lucky is caught switching rings or changing the tilt of the table, he yells, "Hey Rube!" to alert the other circus workers, ducks out the back of the booth, and uses his *ring of invisibility* to escape to the back lot until things calm down. Lucky runs a clean operation for the next several days after such an incident. Thus far, no such incident has come to Jack Mooney's attention.

Lucien "Lucky" Shandor

7th Level Male Half Elf Thief

STR: 12

INT: 12

WIS: 9

DEX: 16

CON: 11

CHR: 15

COM: 16

AC Normal: 5

AC Rear: 7

Hit Points: 29

Alignment: Chaotic Neutral

Languages: Common, Elvish, Circus Jargon

Weapon Proficiencies: Dagger, dart short sword

Nonweapon Proficiencies: Juggling (16), disguise (14), read lips (10), sleight of hand (16)

Magic Items: *Boots of speed*, *ring of invisibility*, *ring of protection* +3

Thief Skills:

PP OL FT MS HS DN CW RL

95 35 40 50 60 45 95 20

Appearance: Lucky is tall for a half elf, at 5'11 1/2". He has short blond hair that frames his boyish face, and piercing green eyes that dance when children come to his booth with copper pieces held out to play. Lucky is 30 years old, and has spent about one-third of his life with the Jack Mooney & Sons Circus. He considers the circus his family and does not cheat fellow employees.

Background: Lucky is a loner who has always put his best interest first, and for Lucky that means getting rich at his customers' expenses. Still, he is confident his game is not hurting anyone; he believes the customers are being entertained, and therefore their money isn't being stolen. Despite his love of money, however, the half elf has no great plans for it. He enjoys the circus life and doesn't want to live anywhere else. When he accumulates too much wealth to comfortably carry around on the road he spends it on fancy clothes and jewelry, the former of which he wears while tending his game.

Lucky is a talkative man, but only to people paying money to play his game. He is a good source for rumors of what is going on in the city, as he hears quite a bit of gossip from his position in the midway. He likes to spread gossip, too. If adventurers begin asking him too many questions about the circus or the area he fabricates wild tales of monsters, riches, and treasure maps.

Midway Games

Dangar's Dunk Tank

Dangar Grunth

1st Level Male Half-Orc Thief

STR: 8

INT: 12

WIS: 16

DEX: 14

CON: 9

CHA: 7

AC Normal: 10

AC Rear: 10

Alignment: Chaotic Neutral (Good tendencies)

Languages: Common, Orcish

Weapon Proficiencies: Dagger

Nonweapon Proficiencies: Gaming (7), Juggling (13), Tumbling (14)

Thief Skills:

PP OL FT MS HS DN CW RL

30 25 5 10 35 15 60 0

Appearance: With his distinctive eyepatch and the cruel taunting calls he uses to lure customers to his sideshow attraction, Dangar Grunth has carved himself a comfortable niche in the Mooney & Sons Circus. Though he is rather unattractive, with the piggish snout and beady eyes left to him by his orcish father, he is well liked and has a few good friends in the sideshow.

Background: Dangar Grunth is not a happy fellow. It is difficult to miss his orcish heritage – indeed, Dangar looks far more like an orc than he does a human – and many humans, dwarves, and elves treat him with scorn because of this. From the time he was old enough to recognize the prejudice, he fought it. He quickly learned, however, that fighting insults slung by narrow minds is far more difficult than battling steel wielded by well-muscled sword arms.

Dangar's childhood home was a small village nestled in the foothills of Impiltur's Earthfast Mountains. He left there at age 10 and wandered around the Inner Sea for a few years. It was during this time that he picked up his meager thieving skills. Though he had to steal to survive – for no one seemed interested in hiring him for honest work – Dangar felt guilty

about taking what wasn't his.

Then, on a visit to Ravens Bluff, he ran across the Jack Mooney & Sons Circus.

To Dangar's amazement, the circus was filled with people even he saw as misfits. Seeing a way out of his life of crime, he quickly signed on. Jack Mooney took an immediate liking to the hard-working half-orc. (Perhaps he saw a little of his own half-elf daughter in the boy.) And soon, Jack gave Dangar the opportunity to put together a sideshow attraction.

The half-orc came up with an attraction that would prey upon people's baser instincts, especially their prejudices. Dangar built a dunk tank, in which he himself would be the "hapless" victim.

Each day and each night, Dangar sits in the dunk tank and taunts passersby. His barbs are very pointed; he is an astute observer of the people who frequent the sideshow, and can often pick out a person's weak spot just by the way he or she dresses or walks. More than once he has enraged potential customers enough for them to want to draw a weapon, and he lost his eye in a fight caused by one of his caustic comments.

After the taunts have drawn them in, Dangar offers humans, elves, halflings, and dwarves the opportunity to dunk an orc, at the price of one copper piece for three tries. The less enlightened folk of the Inner Sea area rarely pass up the chance, and Dangar's coffers are often full at the end of each night – a fact that fuels his pessimistic outlook on life.

The operation of the dunk tank is simple. Dangar stands inside the large booth, drawing customers. When enough people are gathered, he takes money from someone, gives them three waterlogged, softball-sized balls, and climbs onto a seat over a large tub of water. The customer then takes aim at a target, shaped like an orc's head and separated from Dangar by a wooden wall (so the customer can't throw the ball at him), and tries to hit it.

To determine whether a character has successfully dunked Dangar requires a check against both Dexterity and Strength. If the PC successfully rolls his Dexterity or lower on a d20, he or she has hit the target. The balls Dangar uses are old, waterlogged, and weighted unevenly, though this is hard to detect, so all checks against Dexterity are made at +2.

In addition to being hit, the orc's head target must be struck hard enough to release the seat, knocking Dangar into the drink. A d20 check against Strength will tell the PC whether or not enough muscle

was behind the pitch to get the job done.

Like many sideshow attractions, however, Dangar has fixed his so that he can make it more difficult for obviously muscular characters to win. A little lever behind the seat allows the half-orc to secretly adjust the tension on the target. If Dangar chooses, he can add enough support to the target that checks against Strength are made at +1, +2, or +3 to the roll.

For almost 15 years, Dangar has made a good living by relying on people's desire to lash out at orcs and half-orcs. That fact doesn't make him particularly happy, but it does keep him well-fed.



Midway Games

Pick A Prize

This is one of the most often-played games on the Jack Mooney & Sons midway. The brightly colored booth festooned with banners and ribbons beckons to circus goers. A sign above the counter is an added incentive: All Players Win A Prize.

This booth displays about 1,000 items, ranging in value from under a copper piece to several gold pieces. Each item, displayed on shelves behind the counter, has a string tied to it, and each string goes through one of three small sleeves that are affixed to the counter. The strings exit the sleeves on the customers' side of the counter. Because there are so many strings it is impossible to tell which ones are attached to which items.

The woman attending the booth, Aetheltheofa, will at a player's request pull on all the strings at once. This raises all the items behind the counter, showing that each is attached to a string.

To play Pick A Prize, the customer selects a string that exits one of the three sleeves. To pull a prize from Sleeve 1 costs one copper piece; from Sleeve 2, one silver; and from Sleeve 3, one gold. A pull on each sleeve shows the possible treasure is in approximate proportion to money risked. The player then selects a string, pulls, and wins the item that rises, which is almost always less valuable than the amount he paid to play.

Aetheltheofa, a good-looking young redhead, keeps up a continual line of chatter pointing out that there is a winner every time. She often suggests to boys passing by that they might win something nice for their girl. If they play, she congratulates them on their success, but is quite sympathetic if they seem disappointed with the prize. In any event, she suggests they try again.

The booth is not quite as honest as it appears. The trick is that while all the strings attached to prizes enter the sleeves, only the strings attached to inferior prizes exit to where the customer can pull them. Thus, there is no chance the customer will win the really valuable items displayed. A few winning strings are kept where the attendant can slip them to a shill when the crowd needs encouragement.

A player can purchase as many strings as desired, but once 200 have been selected during a business day, the attendant closes the booth for a few hours,

explaining that she has to restock. Therefore, even if a wealthy circus-goer bought a large number of pulls, he will gain no major prize. If the player tries to cheat, nearby circus strong-arms will have an unpleasant talk with the offender.

Use the table below to find what the customer has won.

D100 Prize

| | |
|-------|--|
| 01-40 | small statue |
| 41-50 | ring, obviously not magic |
| 51-65 | cheap glass jewelry |
| 66-75 | shoddy, nice-looking weapon |
| 76-90 | small toy |
| 91-98 | banner |
| 99 | reroll, item is worth price paid |
| 00 | reroll, item worth double the price paid |

Most prizes are worth about one-fourth the amount the customer paid to play. This should be obvious to most players after a round or two. As such, the prizes are also useless to use in trade elsewhere.

If a PC examines any small statue won, he sees a small paper edge sticking out of the statue. He must break the statue to examine the paper.

The paper is clearly part of a map. If Aetheltheofa is asked about the paper, she explains that she has heard that a valuable treasure map was lost at the Acmeum Cheapus Statue Factory (true) and never found (true) and was believed to have become part of some of the statues (also true). However, the paper the player has is probably a fake put in by Acmeum to get people to break statues and buy more. Most people by now have caught on to the scam, so the player will not be able to sell the map piece.

However, it is always possible an error was made and the player really could have a portion of a treasure map that would lead to an adventure.

Aetheltheofa Wilfora

0 Level Female Human

STR: 9

INT: 6

WIS: 6

DEX: 13

CON: 12

CHA: 17

AC Normal: 10

AC Rear: 10

Hit Points: 3

Alignment: Neutral Good

Languages: Common, limited Dwarvish, limited Elvish

Weapon Proficiencies: Dagger

Nonweapon Proficiencies: None

Appearance: Aetheltheofa stands 5'10" tall, weighs 150 pounds, and has curly red hair and brown eyes. Her tan face has a smattering of freckles. While her normal midway attire is colorful and not quite revealing, it definitely fits her snugly and loosely in just the right places to attract men to Pick A Prize.

Background: Born in the circus, the 16-year-old Aetheltheofa is pleasant and kind-hearted. She is loyal to her mother, who has taught her a lot about circus life, and has finally given up asking about her father, who she never met. Aethel lacks the temper associated with her red hair. She likes encouraging people to do things (in particular to spend money at her booth or on her). While completely uninterested in adventuring, she will happily listen to all adventuring stories – at least while the talker is playing at the booth – and will appear to admire any player's great accomplishments.

Aetheltheofa's mother has warned her about predatory males who are out for no good. But those warnings have had the opposite effect on the young woman, and she is overtly looking for some attractive fellow to sweep her off her feet. She is rather disappointed the circus men she dates are such gentlemen. She does not know they are so polite and keep their hands to themselves because they fear Aetheltheofa's mother, Eadwyn. If a player character chooses to romance Aetheltheofa, there is a good chance Eadwyn will attempt to force the adventurer into a swordpoint wedding ceremony.

Actually, Aetheltheofa is a true innocent, trusting in everyone and unable to see evil even in the most obvious threat. She also believes herself incapable of evil and would be shocked to learn she is running a con game. (Her mother arranges the sleeves so the rubes cannot win. She wisely doesn't feel her daughter can be trusted to do it right.)

Her innocence is the main reason she runs the booth so well. Athel is so openly honest the customers assume everything she is doing is honest.

She is not very observant. After running the booth for more than a year, she has yet to notice that no big prize is ever won, except by skills. Nor does she really

Midway Games

understand what skills are. She merely knows that if there is a good crowd that is not buying, she is to make a certain signal and one of the circus folk, dressed like a hick, will come over. She is to give him a certain string. It certainly will not occur to her that the odd way she holds the sleeve is to disguise the transfer of the winning string.

Eadwyn Wilfora

2nd Level Human Female Thief

STR: 8

INT: 14

WIS: 16

DEX: 15

CON: 6

CHA: 10

AC Normal: 9

AC Rear: 10

Hit Points: 2

Alignment: Neutral

Languages: Common, Elvish, Dwarvish, Halfling

Weapon proficiencies: Dagger, short bow

Nonweapon Proficiencies: Disguise (9), gaming (10), appraising (14)

Thief Skills:

PP OL FT MS HS DN CW RL

60 25 5 25 20 15 60 --

Appearance: Eadwyn is 55 years old, but looks considerably older. She is 5'8" tall, weighs 150 pounds, and has blue-gray eyes and wavy gray hair. She looks to be (and basically is) one of the common workers around the circus.

Background: Raised in an orphanage with no knowledge of her parents, Eadwyn left at the first opportunity and started working odd jobs in taverns and other service establishments. She lived this way for nearly 30 years until her pickpocketing of customers got too obvious and she found it progressively harder to find work.

This development forced her to truly be on her own. Eadwyn soon met a man who said he was going to "invest" her considerable earnings and stealings in a circus. She trusted him and gave him her savings. He left the next day on a business trip to handle her money. She never saw him again. He left her broke and pregnant. With no place else to go, Eadwyn

wandered the streets looking for work. She eventually found a job with the Mooney & Sons Circus, and has worked as a circus washerwoman and pickpocket ever since. Her establishment, Pick A Prize, opened about two years ago and was funded by her ill-gotten gains.

Eadwyn is grim, highly cynical, and self centered. She assumes the worst of everyone, does no favors, and expects none. Honesty is not Eadwyn's policy, although she doesn't actively try to hurt others. Her only love is her daughter, Aetheltheofa, who she blindly loves and has overprotected all her life. Whatever sacrifice is needed for Aethel's good (which may not be what Aethel wants) will be made. Whoever is a "threat" to Aethel had best watch Eadwyn.

Since Eadwyn deems it unlikely she will live more than another five years, much less be able to protect Aethel that long, she is searching for a substitute protector, preferably a wealthy husband. However, recalling her own troubles with men, she is being very selective.

Eadwyn will encourage any PC who appears to have some wealth and holdings to court Aethel. The PC must seem willing to protect her. All others get run off at dagger point.

Eadwyn can be friendly if the situation seems to her advantage. In fact, if a customer were to have a yen for older women, and has gold, Eadwyn would quickly warm up to him and seem very pleasant. However, she prefers picking pockets to romance. If she is caught stealing, she'll rely on claims of "just a mistake" and being a poor helpless old lady. If caught, she'll lay low until the circus gets to a new town, then start picking pockets again. She does not realize that Jack Mooney probably will turn her over to the local authorities if she is caught doing anything illegal. She believes that Mooney, being a circus promoter, is every bit as shady as she is.

Arthur's Archery

Arthur's Archery is among the more popular games of skill – especially among adventurers and young men.

There are no games for children here. However, there is a special walled section where children can pay one copper piece to shoot ten arrows at a target. The children's bows are specially designed so they do not require much strength to pull.

There are three levels of competition

open to youths and adults – Contestant, Bowman, and Archer.

Contestant is the least difficult level and is the one most commonly attempted. Each contestant pays one silver piece and is given three arrows. The bullseye has three valid target areas; the outer is equivalent to AC 6, and hitting it is worth 1 point; the middle section is treated as AC 4 and is worth 2 points; and the center is treated as AC 2 and is worth 4 points. If a patron scores six points with three arrows, he or she will be given a choice of a colorful children's toy bow, a tiny silver pin in the shape of an arrow, or a free pass to use at the Bowman level. The child's toy and the pin are worth about 10 silver pieces each.

Bowman is the next highest degree of difficulty and costs five silver pieces to enter. The majority of the participants usually do not have the skill to match their egos, and is thus the largest money-maker for the booth. As in the previous skill level, the target has three valid areas, but they are smaller and the target is farther from the shooter. Contestants can shoot three arrows – again, provided by the booth. The outer area is AC 2 and is worth 1 point, the middle area is AC 1 and is worth 2 points, and the center is AC 0 and is worth 3 points. If a total of six points are scored, the contestant can choose from a pass to the Archer's level, a tiny gold pin in the shape of an arrow, or a silver pin in the shape of a drawn bow. The latter two prizes are worth 4 gold pieces each.

Archer is the top level and costs one gold piece to enter. It is not entered very often due to the high cost and the difficulty. However, when there are Archer contestants, there is usually a crowd. In this event, the contestant is given three arrows to fire at moving targets – six-inch tall glass figurines that swing back and forth on a thin cord. The contestant must break all three figurines (AC -2) to win, and winners are given a choice of a small silver arrow pin set with a tiny pearl (value 10 gold pieces) and a coupon good for a glass figurine (value to 10 gold pieces). It is unusual for many people to win at this level, so if the glassblower receives several coupons at a time for glass figurines, he comes to the booth to validate them.

Contestants who win three times at any level are turned away from the booth for the remainder of the day.

The bows and arrows used at the booth are of good quality. The proprietors insist

Midway Games

that all entrants use the booth's equipment, as they do not want adventurers with magic weapons improving their odds.

The attraction has three proprietors – the owner, James Arthur, who used to be an archer in the Lord Mayor's guard; an employee, Trenpock Feldsong; and an apprentice, Rafance Bilfor.

James Arthur

5th Level Male Human Fighter

STR: 17
INT: 14
WIS: 12
DEX: 18
CON: 15
CHR: 15
COM: 15
AC Normal: 5
AC Rear: 9
Hit Points: 34
Alignment: Neutral Good
Languages: Common

Weapon Proficiencies: Long bow, short bow, crossbow, hand crossbow, long sword

Nonweapon Proficiencies: Bowyer/fletcher (18), hunting (11), fire-building (11)

Magic Items: *Long bow +1, long sword +1, ring of protection +1, and 20 arrows +1*

Appearance: James is 6'3" tall, has a lean, but muscular build, and wears his long gray-streaked black hair tucked up under a bright green cap. Although 44 years old, James is in very good physical condition; he attributes it to the circus life and his efforts to keep up his archery skills.

Background: After many successful assignments, James left the Lord Mayor's employ – in the company of Trenpock, an old army buddy – and came to work for Jack Mooney. James said the change in career was to keep him from getting bored. However, Lord Mayor Charles Oliver O'Kane jokingly contended it was because James thought the circus might bring back his youth. Inwardly, James believes O'Kane might be correct.

James was a sergeant in charge of the archery division. The position taught him how to use a deep, commanding voice that helps attract business to his booth. During one particularly dangerous assignment, his division was guarded by an infantry platoon commanded by Tren-

pock Feldsong. The two became close friends.

James enjoys his current career much more than his military past, even though his former job made him a very eligible bachelor in the social circles. He has no plans to leave the Mooney & Sons Circus.

Trenpock Feldsong

3rd Level Male Human Fighter

STR: 18/79
INT: 11
WIS: 12
DEX: 15
CON: 17
CHR: 9
COM: 9
AC Normal: 9
AC Rear: 10
Hit Points: 31
Alignment: Neutral Good
Languages: Common, Circus Jargon

Weapon Proficiencies: Long sword, broad sword, pike, dagger, long bow

Nonweapon Proficiencies: Cooking (11), fishing (11), endurance (17), running (12)

Magic Items: *Five arrows +1*

Appearance: Trenpock is a compact muscular figure at 5'6". He is 35 years old, has close-cropped dark brown hair, and pale blue eyes. Although clean, Trenpock shaves infrequently, and it often looks like he is attempting to grow a beard.

Background: Trenpock lost his left hand when his shield was ripped from his arm in combat. He refused to give up the warrior's life, however, and had a double metal hook fashioned to replace his lost hand. The hook allows him to continue using a shield and a long bow without any penalty.

He left the city's militia three years ago when he wounded a young urchin who he mistook for a common thief. Although the urchin lived, Trenpock was forever marked by the incident. It took little persuading on James' part to get him to join Jack Mooney's circus.

Trenpock does most of the manual labor involved with Arthur's Archery and often helps out with nearby rides and other attractions.

Rafance Bilfor

0 Level Male Half Elf

STR: 15
INT: 12
WIS: 9
DEX: 17
CON: 15
CHR: 13
COM: 14
AC Normal: 7
AC Rear: 10
Hit Points: 4
Alignment: Lawful Neutral
Languages: Common, Circus Jargon

Weapon Proficiencies: Long bow
Nonweapon Proficiencies: Juggling (17)

Magic Items: *Two arrows +1*

Appearance: Although Rafance is 17 years old, he looks more like a human boy of 12. He stands 4'6" tall, weighs 108 pounds, and has light blond hair and a smattering of freckles on his cheeks. His most unusual feature is his eyes – one is blue and the other is green.

Background: Rafance is fascinated by elves, even though he was raised in a human orphanage. He feels at home in the circus because of his background. Many other circus employees are orphans or ran away from home. He was taken in by James and Trenpock, and he is hopeful that between the two he can learn a few fighting skills. In the meantime, however, he is content to work the booth and do a little juggling on the side. He sometimes fills in for sick clowns because of his juggling talent.

At Arthur's Archery, Rafance is in charge of the children's range and is responsible for keeping the entire booth tidy. He is very good with children; perhaps they relate to him because of his size. He only calls for James if there are any confrontations with children's parents who do not believe their youngsters should be playing with "dangerous weapons."

Midway Rides

For The Byrds

For the past five years the prize attraction of the Jack Mooney & Sons Circus has been the flying galleon *Ravenstar*. Crowds gape in awe at the breathtaking sight of the ornate airship floating above the tops of the circus tents. People line up by the score to ride this magical wonder, which is operated by the Byrrd twins, Ramen and Reman.

The ride's admission is two gold pieces for adults, two silver for children. Reman and Ramen each take day-long turns manning the *spelljammer helm*. Whichever of the twins is not occupied there runs the show. Customers board the ship by means of a gangplank dropped from the ship. Although some of the customers complain that the price is a bit steep, after a thrilling flight through the clouds they admit that it was worth even more.

The *Ravenstar* only operates as a ride during daylight hours. Customers are treated to a lengthy ride around a city's environs and through several cloudscapes. Occasionally the twins offer chartered moonlight cruises, where the ship's railings are dotted with *continual light* sticks and a bard strolls along the deck, singing. These cruises cost 200 gp and are usually chartered by nobles, city officials, and wealthy adventurers.

When the mood strikes them, the twins live up the ride with illusionary spells of a roc, dragon, or other terrible threat heading straight toward the ship. As the passengers cringe in terror, the vision flies to the craft, then disappears.

In addition to serving as a ride, the *Ravenstar* uses its large cargo hold to transport circus equipment and supplies to each new location. If the traveling circus is jeopardized by wandering monsters or other unfriendly forces, Ramen and Reman use the ship as an aerial battle platform.

Despite working with the ship for the past five years, the twins do not know the *Ravenstar's* full capabilities, and they have no idea they can use it to travel into space. The twins are simply happy to have the ship and make money from its operation. The crew is made up of trustworthy sailors who consider themselves fortunate to be on such a marvelous craft.

The *Ravenstar* is actually the brainchild of the twins' father, B'eeg Byrrd, an eccentric wizard. The wizard had learned space travel was possible, and contacted a secretive merchant who was capable of

constructing the galleon. Unknown to B'eeg, however, this merchant was a member of an alien race called the Arcane (see the *Spelljammer* boxed set, *Lorebook of the Void*).

B'eeg commissioned the construction of the ship, using all of his wealth. The *Ravenstar* appears similar to other spelljamming galleons, and it gains its ability to fly through the use of a *major spelljamming helm*, which converts the magical power of a seated individual into propulsion for the ship. This special chair is hidden in the galleon. The *Ravenstar* boasts one unique additional feature. B'eeg ordered a magic keel that would allow the ship to automatically hover one meter above any surface. This means if the *Ravenstar* were to lose its spelljammer helm, the ship would not crash as long as the keel was intact. The keel functions independently of the spelljammer helm.

Ramen and Reman acquired the *Ravenstar* after returning from an adventuring stint to learn their father had been lost at sea and was presumed dead. Their grief passed swiftly. What grieved them more was news that their father had left them copperless. Searching the wizard's records, they found their father had sunk all of the family's wealth into a ship that could fly through the air.

Actually, the wizard's notes read "through space," but Ramen and Reman dismissed this as a delusion. Delivery of the craft was supposed to take place in a few days on a secluded mountain.

The twins kept the appointment, though neither of them expected anything to come of it. They believed their father had gone mad and was taken in by a con man. However, their thoughts quickly changed when they saw the *Ravenstar* drop from the sky. A hooded figure floated down from the craft and presented the twins with a scroll that outlined the ship and its functions. Then the hooded figure and his crew disappeared into the night. The twins did not notice the dark shape of a second ship that transported the hooded man and crew away.

The Byrrd brothers now had the fabulous *Ravenstar*, but they weren't sure what to do with it. The thought of spending years learning how it worked did not excite them. The ship had obvious military and market value, but the pair did not relish the idea of giving up the wondrous invention. As fate had it, the Mooney & Sons Circus was returning to Ravens Bluff for the winter. The twins thought the circus would be a perfect

place for such a craft, and Jack Mooney did not hesitate to accept them into the circus family – especially after being treated to a brief ride.

Adventurers would be hard-pressed to convince the twins there is more to the *Ravenstar*. Persistent characters might be able to eventually get the twins to talk about how they acquired the ship. However, characters who act too pushy or who doggedly pry will find themselves facing a pair of annoyed Byrrd mages, a score of angry sky sailors, and other circus workers who are just a "Hey Rube" away.

Ramen Byrrd

5th Level Male Human Wizard

STR: 13

INT: 17

WIS: 15

DEX: 18

CON: 12

CHR: 14

AC Normal: -1

AC Rear: 3

Hit Points: 16

Alignment: Neutral Good

Languages: Common, Elvish, Halfling

Weapon Proficiencies: Dagger

Nonweapon Proficiencies: Ancient languages (17), engineering (14), reading/writing (18), spellcraft (15)

Magic Items: *Bracers of defense AC 3, dagger +2*

Spells/day: 4 2 1

Spell Books

Level 1 Spells

| | |
|----------------------|-----------------------|
| <i>Alarm</i> | <i>Audible Glamer</i> |
| <i>Change Self</i> | <i>Detect Magic</i> |
| <i>Feather Fall</i> | <i>Hypnotism</i> |
| <i>Magic Missile</i> | <i>Spider Climb</i> |

Level 2 Spells

| | |
|---------------------|------------------------|
| <i>Alter Self</i> | <i>Continual Light</i> |
| <i>Detect Evil</i> | <i>Flaming Sphere</i> |
| <i>Invisibility</i> | <i>Know Alignment</i> |
| <i>Mirror Image</i> | <i>Stinking Cloud</i> |

Level 3 Spells

| | |
|----------------------|--------------------|
| <i>Clairaudience</i> | <i>Fireball</i> |
| <i>Gust of Wind</i> | <i>Hold Person</i> |

Midway Rides



Reman Byrrd

5th Level Male Human Wizard

STR: 12
INT: 18
WIS: 14
DEX: 18
CON: 11
CHR: 14

AC Normal: -1

AC Rear: 3

Hit Points: 16

Alignment: Neutral Good

Languages: Common, Gnomish, Dwarvish

Weapon Proficiencies: Staff

Nonweapon Proficiencies: Ancient languages (18), herbalism (16), reading/writing (19), spellcraft (16)

Magic Items: Bracers of defense AC 3, staff of striking

Spells/day: 4 2 1

Spell Books

Level 1 Spells

Burning Hands
Feather Fall
Identify
Sleep
Ventriloquism

Charm Person
Friends
Phantasmal Force
Unseen Servant
Wizard Mark

Level 2 Spells

Blindness
Detect Invisibility
Improved Phantasmal Force
Levitate

Deafness
ESP
Knock
Summon Swarm

Level 3 Spells

Clairvoyance
Melf's Minute Meteors
Spectral Force

Flame Arrow
Secret Page
Suggestion

Appearance: Ramen and Reman are 29 years old, have willowy blond hair, and blue-green eyes. Ramen is 5'6" tall and weighs 145 pounds, while Reman is 5'6" tall and weighs 150 pounds. It is difficult to tell the two apart, even though they always wear contrasting clothes. Ramen prefers dark browns and blues, while

Reman likes pale colors such as peach, beige, and ivory. The pair can wear each other's clothes, and will swap outfits to confuse the sailors and other circus workers. Further, their speech patterns are almost identical – some believe they work hard to sound alike.

Background: The sons of the once wealthy wizard, B'eeg Byrrd, who lived on the outskirts of Ravens Bluff, knew from an early age that they would study magic. Their mother left shortly after the boys were born; B'eeg never told them why. B'eeg spent a great deal of time with the boys, and continually impressed upon them that they had the right to choose their own professions. However, the look in B'eeg's eyes told them their choices were limited to wizards or frogs. The twins wisely opted for the former.

Ramen and Reman have a unique empathy between themselves; if one gets an idea the other is quick to pick up on it. They spend hours chatting about new routes for the Ravenstar, unusual uses for spells, and speculating about Mooney's sons' motives and work ethics. To facilitate private conversation, they learned an obscure ancient tongue that apparently no other circus workers can understand.

Midway Rides

Tumble Tower

Tumble Tower is an impressive 60-foot-tall structure composed mostly of wood and rope. People who dare this ride climb to one of three levels and leap off the tower.

Despite numerous warning signs indicating otherwise, the jump is safe, due to its *safety nets*.

After paying the one copper piece admission fee, patrons climb a 10-foot ladder to the first level. At the top of the ladder is a painted wooden sign which reads, "The Halfling Hop." Underneath the title is smaller print reading "For a small thrill with little chance of danger." To prevent accidental falls, three sides of the platform are blocked by a rope fence. At the fourth side stands an attendant dressed in black clothes. He beckons the patron forward, warns him not to dive head first, and rings a bell to signal other attendants that someone is about to jump. Those looking over the edge of the platform see a very rough stone floor littered with sharp objects.

The floor is a *permanent illusion* and is just above the *safety net* (see below). Both the spell and the *safety net* have been positioned in a wooden box with sides just over 10 feet long. The floor of the box is lined with one foot of padding.

A jumper falls at normal speed until he hits the *safety net* effect and then falls gently to the padding. When a jumper touches bottom, a halfling hiding at a corner in the box emits a strangled cry for effect. Other people waiting to jump are held back from the edge of the platform, "until the jumper can be removed." Actually, the individual who just jumped is guided out through a small door in the back of the reception box, exiting in an area which cannot be seen by people waiting to climb the tower. After the patron exits, the halfling whistles to let the attendants know they can send another jumper down.

If an individual tries to leap too far from the launch site, he is intercepted five feet out from the platform by a vertical *safety net* which causes him to fall gently straight down.

Those brave enough to go beyond the Halfling Hop are instructed to climb another 10-foot ladder to the next platform, where a sign which reads, "Only the truly stout-hearted should climb to the next level!" After another climb, daring jumpers reach the second jump level,

titled "The Paladin Plunge." It is constructed exactly like "The Halfling Hop" platform and offers the same safety precautions. The only difference besides the height is the attendant, who is dressed as a paladin. He nods to the jumpers and commends them for their bravery. He then offers the same warning about diving head first and rings a bell to warn other attendants about the impending jump.

If patrons choose to go still higher before leaping, they must climb another ladder. On the 40-foot-high platform sits a sign which reads, "The final level of Tumble Tower is not intended for use by mere mortals. Continue at your own risk!" The sign at the top of the ladder leading to the final level bears the title "Dragon Drop." The attendant here wears a green sequined cloak to simulate dragon scales. He chuckles nastily and announces, "a new victim takes the final step."

The tower is tested periodically for safety to make sure the *safety nets* are still functioning. Approximately every hour, each attendant throws a small painted pebble so that it hits the vertical *safety net*. If it does not fall correctly, an alarm is sounded. If a painted pebble (or jumper) lands badly, the halfling sounds an alarm.

Tumble Tower breaks down easily for travel. Component platforms fit easily into the reception box without damaging the *permanent illusion* spell. Room is left for the two *safety nets* (one 100' long and one 200' long) and for the ladders and support poles. The whole ride packs into a 10-foot cube which can be transported by wagon.

New Magic Item

Safety Net: These magical ropes are woven from giant spider or ettercap silk. *Safety nets* usually are found in lengths of 50, 100, or 200 feet. When tied into loops they create semi-permanent *feather fall* effects. These can be placed over openings or suspended in the air.

A *safety net* can operate vertically, horizontally, or at an angle, eliminating inertia directed perpendicularly to it. Thus, a vertical *net* would eliminate the horizontal (forward) inertia of an oncoming missile, but the missile would still fall downward at the normal rate.

An object's inertia is eliminated when any part of the object touches the area of effect of the *net*, as long as the object's weight does not exceed 200 pounds plus a

number of pounds equal to twice the rope's length in feet. For example, a 100-foot *safety net* can stop objects weighing up to 400 pounds. The *net's* area of effect is as long and wide as the loop. The area is centered within the loop and as deep as the loop's shortest dimension. For example, a 100' *net* could be formed into a 20' by 30' rectangle which would have an area of effect 20' X 30' X 20'. The same *net* could form a cylindrical area about 30' wide and 30' deep. Loops with total circumferences less than the *net's* length can be formed with no ill effects. Two or more *nets* can be tied together to form larger loops with no ill effects, but such combination *nets* have weight limits based on the shortest *net* in use.

Midway Rides

The Whitewater

The Whitewater is actually composed of two rides, a water slide and a raft ride, both made possible by a *decanter of endless water* and two captive water elementals. Customers access either ride by climbing a 60-foot-tall stairway. The Whitewater Slide costs one copper piece, and the Whitewater Raft Ride costs one silver piece.

At the base of the tower, patrons of the water slide are greeted by a sign and a permanent *magic mouth*, both of which say the same thing in the Common tongue: "Please remove all armor, weapons, and breakable objects from your person. These may be checked with the operator at the base of the tower." After these conditions have been met, the operators allow patrons to climb the tower. At the 10-foot level, a smaller sign and a quieter *magic mouth* carry a warning (also in the Common tongue): "The management is not responsible for loss or breakage of personal items, or for any injury which may result from actions of the customer."

Patrons pay the admission price at the top of the tower. Those who refuse to pay are sent back down the ladders. Paying customers are allowed to step forward and jump onto the slide. They experience two small jumps, a downward spiral, and large curves along the path of the slide (approximately 150'). At the end, another small jump vaults them from the end of the slide into a large tub filled with water, eight feet in diameter and 10 feet deep. Another worker waits here to aid customers who have trouble making it to the side of the tub. A tube drains excess water into a reservoir under the ride, where it is pumped back to the top of the tower.

The slide is made of beaten steel which has been magically smoothed so customers are not injured. The whole ride is curved to hold water and avoid dangerous angles. Near the corners, sides curve higher than normal to keep patrons from flying off the slide. The section of slide after the final curve is completely enclosed and kept in magical darkness to provide an extra thrill.

Customers for the Whitewater Raft Ride also climb the tower, but on separate ladders. A sign and *magic mouth* at the base of the raft side of the tower state, "Please leave all weapons and breakables with an operator at the tower's base. You may wish to remove any armor for comfort." The disclaimer about breakage and injury

is repeated on this side, again at the 10-foot level.

At the top, customers pay admission (or are sent back down the ladders) and wait for the next available raft. Up to six adult humans or several smaller people can ride in any raft. After it is loaded, the raft is released to float serenely along its artificial stream – for a short time.

The first curve usually causes the round raft to rotate. Shortly after leaving the curve, the raft makes a small jump, splashing water on its passengers. The raft then moves quickly through the steeper and longer second curve, bumping off the sides and rotating. At the end of the curve, the raft meets a more level section of water, causing another splash. Soon afterward, it crosses underneath its previous path, ideally as another raft splashes water over the sides from above. The rest of the ride is fairly calm, except for continued rotation and collisions with sides. A large, rectangular, wooden tub waits at the end to receive the raft. There, passengers are helped from the raft, which is then lifted back to the main platform to begin another circuit.

There are six rafts available for the ride. They travel along an artificial stream composed of wood and reinforced with iron bands. This stream has a squared bottom, and its sides are padded with leather and rattan bumpers. The receiving tub at the end also has a drain pipe to the recirculation reservoir.

Both rides begin at a large platform at the top of the tower. It is described below, with references to the accompanying diagram.

1 The circle shown in this area is the head of a vertical pipe that carries water from the reservoir. The pumping action is provided by two water elementals who use their bodies to push water upward from the reservoir. This area also holds a *decanter of endless water*, set to *stream* mode when the ride is operating; this makes up for water lost to spills, leakage, and evaporation. The vast majority of the water is directed into the stream of the Whitewater Raft Ride, keeping a depth of about two feet in the level sections. A smaller amount goes into the slide, keeping its length wet and slippery.

Water Elementals

Intelligence: Low; Alignment: Neutral; AC: 2; Movement: 6, SW 18; Hit Dice: 12; hp 60 each; THAC0 9; No. Of Attacks: 1; Damage: 5-30 Special Defense: +2 or better weapon to hit; Size: L (12' tall)

2 Water moves through here, at about a quarter-inch depth, to the slide.

3 Customers may stand in the water here before entering the slide.

4 The slide begins its downward slant here.

5 Here, patrons pay the admission price. The operator makes individuals wait so they will not follow previous customers too closely.

6 These are the step platforms to the Whitewater Slide. Customers climb 10 feet to a platform, move ahead three feet, and repeat the process until the top is reached. Platforms are wooden and ladders are steel.

7 These step platforms are constructed exactly like those in Area 6, but lead to the Whitewater Raft Ride.

8 Customers pay the admission price at the top of the ladder leading here, then wind about in line to the rafts. The last part of this platform sits above the water which flows into the artificial stream. An operator waits here to help remove the raft from the chains which support the raft while it is moved into the stream. He also helps passengers into the raft.

9 A raft ready for loading sits here.

10 Water from area 1 flows through here to reach the stream.

11 The stream begins a slight downward slant here.

12 Here the raft moves from the stream into the receiving tub.

13 Passengers leave the raft here, at the end of the stream. The three operators hook the raft to chains from above, so that it can be raised up to the main platform.

14 Three ride operators work here to help rafts complete the ride circuit. After a raft has been hooked to chains by the workers below, the operators here use winches (shown in the diagram) to lift it. The winches are then locked, and the raft is transferred to another set of chains, which are attached to wheels set in a scaffolding above. The raft is pushed over until it is above the loading area. The chains are then released and returned to their starting positions, while one of the workers holds the raft in place with a long pole.

15 This is an access platform at the top of a 60-foot ladder. The ride operators use this to travel between levels of the ride.

The ride is operated by a group of 12 sturdy dwarves who joined the circus after their copper mine folded. Just before joining the circus, they built a tower for a wizard, who offered them a

Midway Rides

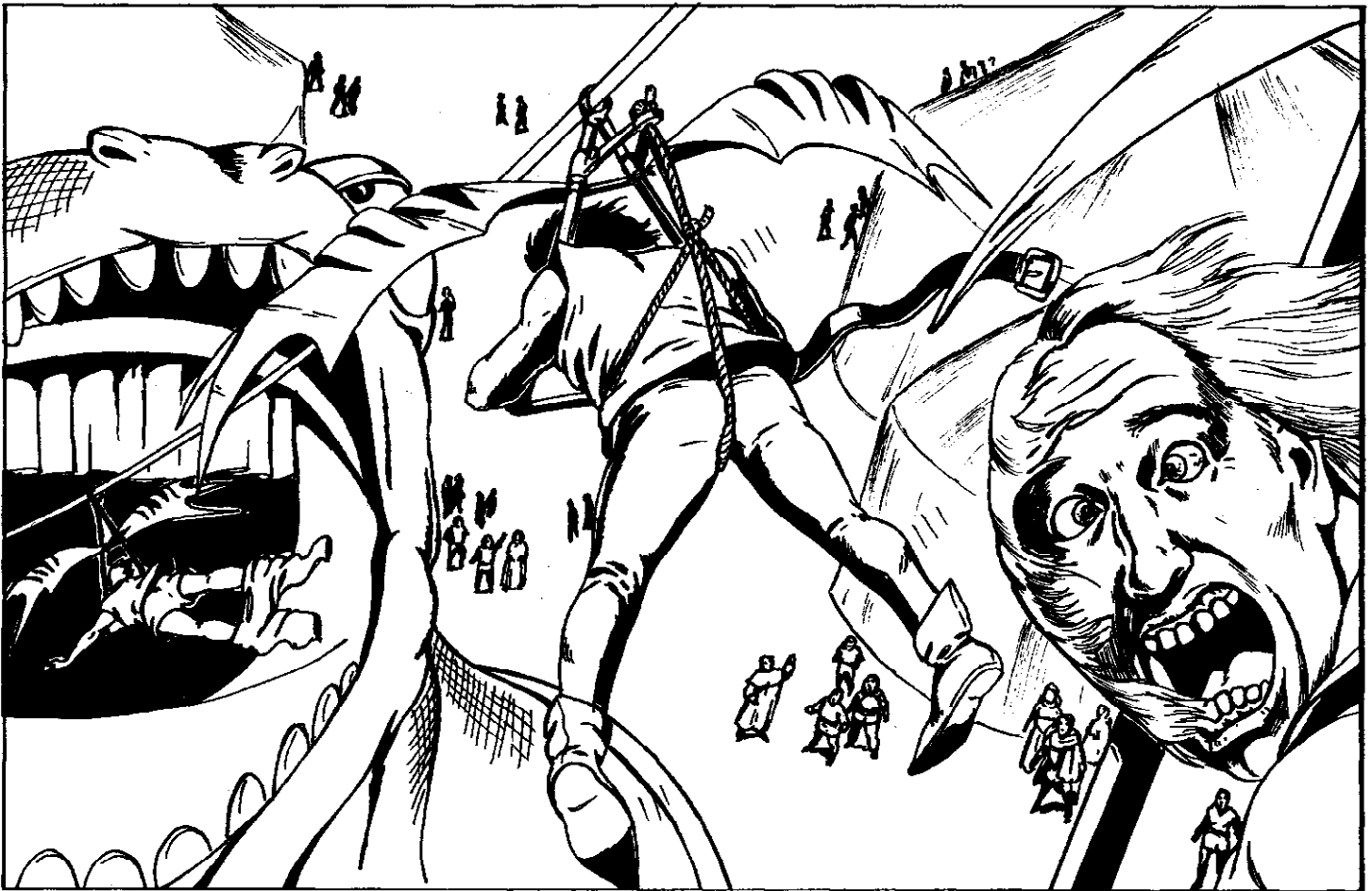

Flight Into The Dragon's Jaws

Circus goers who are at least three feet tall feel like they are flying when they pay a copper piece and enjoy *Flight Into The Dragon's Jaws*.

The ride starts at the top of a 40' tall wooden platform. Riders climb up curvy wooden stairs to get to the attraction, take hold of a set of dragon wings, and "fly" down a metal cable straight into the jaws of a fearsome red dragon.

Actually, the ride is a lot more complicated than that and requires regular maintenance to keep it safe. At the top of the ride's platform is a rope made of strong fibers woven with metal; it extends down and curves around tall, thick poles. The rope is secured to the poles with steel rings. The path of the rope looks like the curved tail of a reptile and ends inside a wooden structure painted to resemble the jaws of a big red dragon.

Riders at the top hold on to a metal equilateral triangle, which is 2' per side. At the top of the triangle is a pulley device that is looped around the main rope, and above that is a metal decoration shaped like dragon wings; these wings have holes driven in them, and they emit a screaming-whistling sound when the rider is in motion. To make the ride safe, thick leather straps are tied around the rider and secured to the triangle; if the rider lets go of the triangle, he or she won't fall.

At the end of the ride a release hook disconnects the triangle and deposits the rider in a soft bed of straw and cloth.

One rider can go down the rope every 10 seconds, and there is rarely a time when the ride is not busy. At the base of the ride is a red mark on one of the platform's poles. The mark is exactly three feet off the ground; patrons who are shorter than the mark are turned away from the ride.

The proprietor and engineer of the ride is Amos Polgate. His assistant is a young woman named Linda Grettich.

Amos Polgate

5th Level Male Human Wizard

STR: 9

INT: 18

WIS: 15

DEX: 17

CON: 10

CHR: 14

COM: 14

AC Normal: 7

AC Rear: 10

Hit Points: 13

Alignment: Chaotic Good

Languages: Common, Elvish, Halfling, Dwarvish, Gnomish, Centaur, Orcish

Weapon Proficiencies: Dagger

Nonweapon Proficiencies: Engineering (17), spellcraft (16)

Magic Items: *Murlynd's spoon, dagger +1, boots of levitation*

Spells/day: 4 2 1

Midway Rides

Spell books

Level 1 Spells

| | |
|----------------------|----------------------|
| <i>Change Self*</i> | <i>Charm Person</i> |
| <i>Feather Fall*</i> | <i>Hypnotism</i> |
| <i>Identify</i> | <i>Jump*</i> |
| <i>Mount</i> | <i>Spider Climb*</i> |

Level 2 Spells

| | |
|----------------------|--------------------|
| <i>Alter Self*</i> | <i>Deepockets*</i> |
| <i>Locate Object</i> | <i>Wizard Lock</i> |

Level 3 Spells

| | |
|-------------|--------------------|
| <i>Fly*</i> | <i>Secret Page</i> |
|-------------|--------------------|

* Spells usually memorized

Appearance: Amos, a 6-foot-tall man with a thin build and thinning brown hair, was a generalist wizard who gave up advancing in the profession because his love of engineering crowded out his spells. He still retains his ability as a fifth level wizard, however, and sometimes uses his spells and magic items to assist with his ride.

Amos weighs 165 pounds, has dark brown eyes, and tanned skin from being outside so much. Although he is 45 years old, he acts very much like a child, always getting excited about new things and always looking at the world with wonder.

Background: Amos's childlike nature drew him to the circus. A wealthy Ravens Bluff native, the wizard went to the circus nearly every day when it was wintering in the city and often traveled out of town to see the circus perform on the road. Several years ago Jack Mooney jokingly told Amos he should join the circus; it would save him money because he wouldn't have to pay to get in. Amos thought he was serious and at once accepted his offer.

Amos engineered his own ride, which he believes is the most popular attraction – outside of the Big Top show, and he is responsible for supervising the set up of all large rides and complex structures at the circus.

He makes sure each structure is safe. Even though he built many safety features into his own ride, he still memorizes *feather fall* and other spells in the event something might go wrong while a patron is riding. As another precaution, he doesn't let young children ride it – hence the requirement that riders must be at least three feet tall. This has drawn the ire of many gnomes and a few halflings who

cry discrimination. However, Amos stands by his red mark.

Amos enjoys his own ride and uses his *change self* and *alter self* spells to take on different appearances when he rides it a few times a week. In addition, after *Flight Into The Dragon's Jaws* closes at dark (Amos claims it is for safety reasons) he wanders through the midway and rides the other attractions. The other ride operators do not charge Amos, as he often helps them solve mechanical problems.

Adventurers encountering Amos will find him giddy and pleasant. He occasionally hires adventurers to travel to faraway places in search of engineering tomes.

Linda Grettich

0 Level Female Human

STR: 10

INT: 14

WIS: 10

DEX: 13

CON: 11

CHR: 12

COM: 15

AC Normal: 10

AC Rear: 10

Hit Points: 3

Alignment: Lawful Neutral

Languages: Common, Dwarvish

Weapon Proficiencies: None

Nonweapon Proficiencies: Cooking (14), rope use (13), animal handling (9)

Magic Items: *Ring of feather falling* (a gift from Amos)

Appearance: Linda is Amos's only assistant. She is 15 years old, is 5' tall, weighs 100 pounds, and has honey-brown hair and light brown eyes.

Background: Linda has been with the circus for less than a year, joining it on the road when she ran away from home. Linda had a bad home life and was taken in by Amos, who considers her a daughter.

Her job is to look over each patron getting off the ride to make sure they are not hurt, and to watch those getting on to make sure they are not too short or are not carrying weapons or other sharp objects that could hurt them when they land.

Although she does not share Amos's love of the circus, she stays because the circus employees are like a big family, and

she is pleased to draw wages. When she is not helping Amos she cleans up around the animal cages. Linda is not sure what she wants to do with her life, and is not sure how much longer she wants to stay with the circus. She often dreams about becoming an animal trainer.

The Leaping Lizard

A sign at this ride's ticket counter reads "ride at your own risk." Many of the circus patrons cannot read, however, and those who can usually elect to ride anyway.

The leaping lizard is a mechanical contraption created by the ride's proprietor Archibald "Archie" Meadeeze. The metal creature, which looks vaguely like a small dinosaur, is covered with the skin of a young green dragon to make it appear more lifelike. A colorful leather saddle sits on the beast's back.

Patrons pay two copper pieces to ride, and only one can ride at a time. The patron sits on the saddle and attempts to stay on the beast while three verbeeg who work for Meadeeze operate it. The ride lasts five rounds or until the patron falls off, whichever comes first. If the patron is able to stay on the contraption until the ride is over, he gets one copper piece back.

The ride has three motions, each operated by a verbeeg – vertical, or jumping, which is an up and down movement made possible by a lever and a fulcrum; pitch, a forward and backward bucking motion that works on a bell crank arrangement; and yaw, a side to side spinning movement operated by a rope and pulley.

To determine if a rider stays on the leaping lizard, average the rider's Dexterity and Strength, dropping all fractions. The rider must roll under this number on a d20 for each of the ride's five rounds. If the customer has an airborne riding proficiency he can use his proficiency number if it is higher. The ride stops if the rider falls off.

Because mounds of hay and shredded cloth circle the contraption, injuries are rare and never have been serious.

Midway Rides

Archibald "Archie" Meadeeze

Male Gnome Mechanical Engineer

STR: 9
INT: 18
WIS: 10
DEX: 15
CON: 11
CHR: 15
COM: 11
AC Normal: 9
AC Rear: 10
Hit Points: 20

Alignment: Neutral (with Chaotic tendencies)

Languages: Common, Gnomish, Dwarvish, Elvish, Verbeeg, Circus Jargon

Weapon Proficiencies: Dagger, brass knuckles, short sword, mace

Nonweapon Proficiencies: Engineering (15), drafting (16) reading/writing (19)

Magic Items: *Chain mail* +2 (never worn)

Appearance: Archie is an unusually small gnome at 2'6" tall and 48 pounds. He is 69 years old, has light brown hair, hazel eyes that twinkle when he is engineering a new device, and a pronounced cleft chin that adds to his odd appearance. He usually dresses in somber greens and grays, however he always makes certain to add a splash of color such as a bright orange neck scarf, a red satin belt, or a lemon yellow cap.

Background: Archie is a retired adventurer. He traveled with a small band of halfling thieves more than a decade ago. He was the group's only fighter and rose to third level before growing tired of risking his life and not getting a full share of the profits. He was positive the halflings were skimming treasure off the top of every take; but he could never prove it. Archie attempted to sign on with another adventuring group. However, he couldn't find one that would take a 2-1/2-tall fighter seriously.

Utterly depressed, the little gnome went to Jack Mooney & Sons Circus, which was making a special appearance in Waterdeep. He was entranced by the rides and attractions and immediately began to scheme how to make his own rides. He followed the circus to several towns before getting up the nerve to ask Mooney if he could sign on.

Mooney told Archie if he came up with a suitable ride, he was welcome. The

gnome spent several months pouring over designs and settled on *The Leaping Lizard*, which would require a few large, strong people to operate. He spent most of the treasure he had accumulated on parts and materials and advertised for a trio of strong laborers. The only taker was a salty old adventurer who offered to sell Archie three verbeeg he had captured. Archie, desperate to join up with Jack, agreed, and acquired Logroller, Darkpuss, and Darkpuss. Getting the permits to keep monsters inside of Ravens Bluff and a few other cities, however, took a few weeks' work and assistance from Jack Mooney.

Archie and his giants have been with Jack Mooney for the past two years. The little gnome has never been happier.

Logroller

Verbeeg Foreman

Intelligence: Very (11-12)

Alignment: Neutral

Armor Class: 3

Movement: 18

Hit Dice: 5 + 5

Hit Points: 44

THAC0: 15

No. of Attacks: 2

Damage/Attack: 1-6 + 6/1-6 + 6

Special Attacks: Nil

Special Defenses: Nil

Magic Resistance: Nil

Size: L (9' tall)

Logroller has long black hair that he ties in a braid with colorful yarn. He weighs 320 pounds, has tanned skin from working outdoors, and is very muscular, even though he appears thin. He usually wears fur and bits of armor, although he tries to dress up the outfits by adding colorful trim like Archie does. Logroller is the smartest of the trio and considers himself in charge of the entire Leaping Lizard operation.

Logroller has come to enjoy the circus life because of the pleasant (at least to him) screams of excited patrons and the ever-present aroma of food. He has found it easy to accumulate treasure while working here, as many patrons drop valuables and coins while they are being bucked around on the ride. Logroller usually picks up the goodies when the ride closes for breaks or for the day. He has learned limited Common and talks with patrons at every opportunity. He has grown rather fond of Archie and watches over him.

Darkpuss and Darkpuss

Verbeeg Workers

Intelligence: Low (5-7)

Alignment: Neutral

Armor Class: 4

Movement: 18

Hit Dice: 5 + 5

Hit Points: 34 each

THAC0: 15

No. of Attacks: 2

Damage/Attack: 1-6 + 4/1-6 + 4

Special Attacks: Nil

Special Defenses: Nil

Magic Resistance: Nil

Size: L (10' tall)

Darkpuss and Darkpuss each weigh about 400 pounds, have short-cropped brown hair to keep it from getting caught in the ride mechanisms, and wear colorful canvas clothes over hides (discarded tent canvas). They have identical statistics because they are twins. However, they have a few minor deformities, which Logroller and Archie use to tell them apart; one Darkpuss has a club foot and a lip that curls down on the left side of his face.

Darkpuss and Darkpuss are not enamored to circus life, as they get nervous with all the yelling children running around. Although, they don't want to leave Logroller, who they have always considered their leader. If something should happen to Logroller, however, Darkpuss and Darkpuss would leave the circus at the first opportunity.

Midway Rides

Jaws Of Death

Jaws of Death is a fun house. Unique among the attractions at The Jack Mooney & Sons Circus, this ride contains several magical effects and demands the attention of at least four attendants. The fun house is constructed in the shape of a blue dragon, and is entertaining, educating, and open to people who weigh at least 50 pounds.

It is the creation of Meril Vill, an aged wizard who spent many years studying dragons. He is responsible for the majority of the enchantments in the ride.

Riders are charged one silver piece each, no discounts are given for children. Two to four patrons go through the dragon at a time, traveling through the internal organs of the beast on a wild journey. The areas and the attractions within are detailed below.

Area 1: The Jaws

After paying the admission price, patrons climb a short staircase under the ever-smoking nose of the dragon. From there they step onto the tongue of the beast, which is kept magically soft and moist. After another climb (or crawl) between the teeth of the creature, patrons reach the entrance to the esophagus. At this point they feel wind rushing in and out of the windpipe, located at the level of their heads.

Area 2: The Esophagus

Next, the participants crawl through a dark area – unless they are shorter than 3' tall and can walk through it. The floor and walls of this tunnel are soft and moist. The tunnel extends 32 feet. Area 2a is a 9' section of the tunnel which slowly rotates due to another enchantment. The rotation is not fast enough to cause careful patrons to fall, but it should disorient them and keep them off balance. At the end of the tunnel is a hinged doorway which must be pushed open before the patrons can enter the stomach. A *magic mouth* at this point encourages any timid or reluctant people to move forward, repeating over and over "The brave will enter. The brave will breathe. The brave will live."

Area 3: The Stomach

This dimly-lit section is filled with murky water. When the hatch from the esophagus opens, the water stays in place because of the enchantments that have

been placed on it. The magic also prevents the water from soaking into the customer's clothing and hair. Another enchantment renders the water breathable, but does not change its consistency. After patrons swim about for a few minutes, two forms appear near the far end of the stomach. These are two first level fighters, one dressed as a sahuagin, the other made up as a bloated zombie with a number of injuries. They herd customers toward the doorway to Area 4. The door is operated by sensitive springs, and anyone landing on the door falls through into the furnace.

Area 4: The Furnace

Patrons fall from the stomach onto a pile of coal just under the trap door. Coal lines the entire floor of this red-lit area, which is warm. The air in here feels stuffy. Jets of fire spew from several points around the room. Patrons are not harmed because of various magical effects. Seconds after the patrons enter, the room begins to grow warmer, the fire jets become more frequent, and the atmosphere grows stifling. As the hot air rises, it causes two trap doors in the ceiling to vibrate and rattle. Ridges in the sides of the furnace allow patrons to climb up to the trap doors and go through them to the furnace pipes.

Area 5: Furnace Pipes

These pipes are 3' in diameter and slant forward. Ridges allow customers to climb up to the open entrances to the windpipe.

Area 6: The Windpipe

Wind rushes through this dimly-lit section, changing direction every few seconds. Permanent *gust of wind* effects, placed at the spot marked "s" in the diagram of the Cardiopulmonary System and in Area 7, create this effect. They simulate the dragon's breathing by blowing alternately.

Area 7: The Lungs

Wind moves in and out of the lungs periodically. The sound of rushing air is magically augmented to be quite loud, making conversation impossible unless people shout. Inward-moving air causes the outer side of each lung (composed of sturdy leather) to billow outward until stretched tight. The changes in air pressure will cause customers' ears to pop as they move through the area. At the inside end of each lung is a weblike membrane

which allows patrons to enter the heart. It repairs itself after people pass through.

Area 8: Pulmonary Artery and Vein

As patrons struggle through the web to enter this area, they will notice a warm, blood-like liquid which flows along the inner side. The "blood" flows from a circular door ahead and to the left, around the room, and back out a similar door on the right side of the forward wall. Like the water in the stomach, the liquid has been enchanted to maintain its integrity, and it will not stick to customers or soak into their clothing. Subtle lighting makes the liquid appear almost blue on the left, and a bright red on the right. A deep pounding noise reverberates throughout this section, emanating from the heart. Customers can enter the heart through either the left or the right door.

Area 9: The Heart

"Blood" flows from Area 9b to 9a, through Area 8, into Area 9c and into 9d. The walls pulse with the beat of the heart, and the smell of blood is strong. Between 9a and 9b is a door composed of flaps which open in time to the pounding, which is almost deafening inside the heart. A similar door is situated between Areas 9c and 9d. Patrons must go through one of these doors. Areas 9a and 9b lead to a vein, and lighting gives the blood here a blue tinge. The entrance to the vein is through a hatch from 9b that periodically opens. Similarly, Areas 9c and 9d lead to an artery, and lighting in those areas make the blood appear bright red.

Area 10: Cranial Blood Vessels

The blood-like substance also flows along these passages, which are 3' in diameter, forcing most customers to crawl through them to reach the brain. Lighting is blue in the left-hand vein and red in the right-hand artery. The smell of blood is strong in these tunnels, which end in open entrances to the brain.

Area 11: The Brain

This egg-shaped area contains a multitude of magic effects. "Blood" flows out of the artery, breaks into a number of smaller streams which move all around the room to enter the vein and flow back to the heart. White light flashes at various points in the room, and flashes like lightning between the points.

Light also enters the room from various points. At the sides, it penetrates dimly

Midway Rides

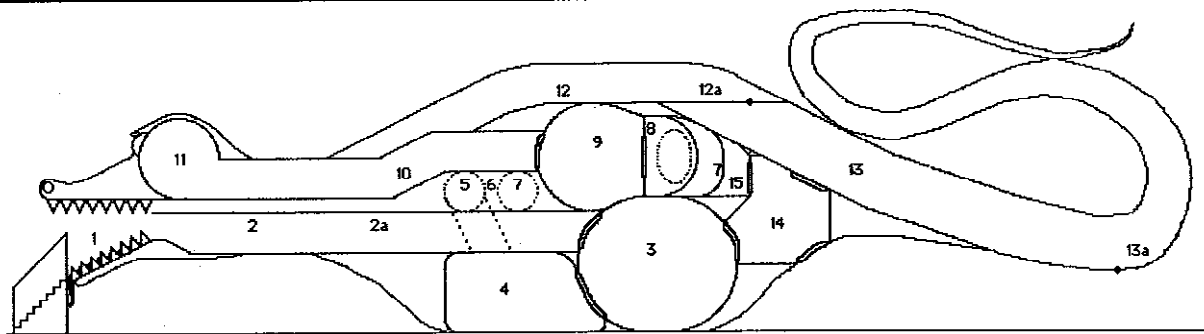

Side View, Cutaway

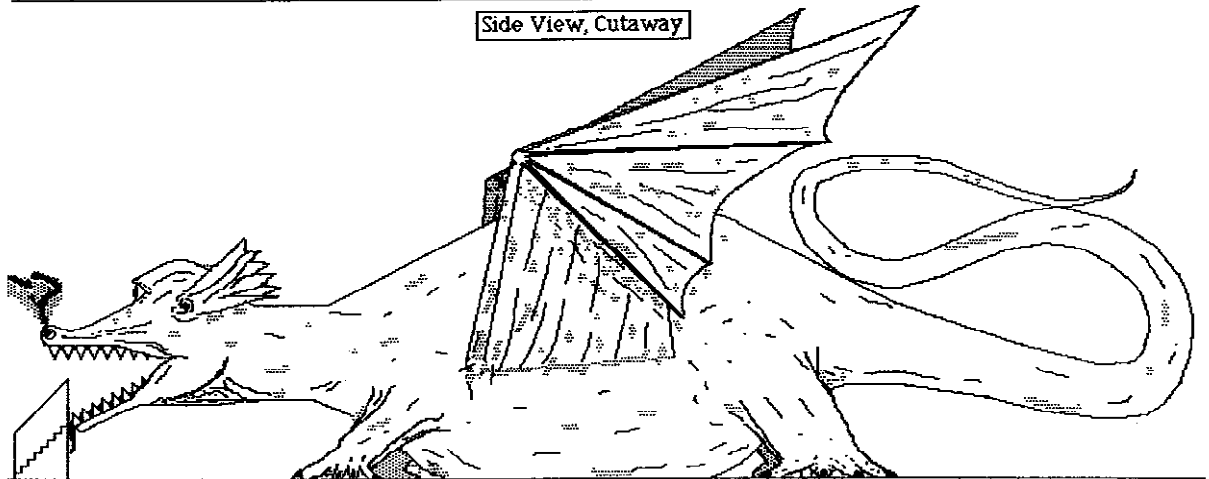

Side View

through "eardrums." A patron who places his head in one of these areas will hear the magnified sounds of the circus outside. Soon after the customers enter, however, their attention will be drawn to the eyes in the front of the room. Stairs allow shorter customers to climb up for a good view.

A sophisticated *programmed illusion* shows a scene of the circus in front of the ride. Patrons then see an increased amount of smoke flow from the creature's nostrils. Flames lick up the sides of the mouth, and the head seems to move (the base of the brain moves somewhat, in concert with the illusion). People on the circus grounds appear to notice; some point and scream. The dragon then launches itself into the air, circles the grounds, and swoops to flame the crowd. After a few passes, accompanied by much screaming, the dragon flies into the clouds. Scenes of clouds are repeated until customers leave the brain.

The exit from the room leads to the spine.

Area 12: The Spinal Cord

The spinal cord is another tunnel that is 3' in diameter, but this one is dry and

spooky. Light races along the sides of the tunnel, giving a lightning-like effect and providing the only light. After eight feet, the tunnel slants upward to continue along the back of the creature. Area 12a is a trap. The rear portion of the platform here is linked by a spring to the top of the spine. When 50 pounds or more of weight is placed on the forward portion of the platform, it overcomes the pressure of the spring and falls down, allowing the rear portion to spring upward. This causes patrons to fall into the tail.

Area 13: The Tail

Customers slide rapidly through the lightless tail to Area 13a, where the ride ends.

Area 14: Control Room

Operators wait in this area until needed. The two fighters who herd people through the stomach wait here between customers, and a service man waits to reset the trap in Area 12a and to handle any other problems that occur. Concealed doors allow access to Area 3 and Area 13.

People enter Area 14 through a concealed door at the rear of the dragon.

A rope ladder can be rolled out for the operators to climb into the room. A normal door leads into Area 15.

Area 15: Service Corridor

This area allows operators to gain access to the sections around the lungs, in case repairs are needed.

General Notes: There are vents throughout the fun house, allowing air to circulate in all areas. Most doors operate only in one direction, preventing patrons from retracing their steps. Groups are sent through at three-minute intervals, so there is little chance for them to bunch up. If people do not exit after a reasonable time, operators fetch them out or call security. Weapons are not allowed into the ride, and the wearing of armor is strongly discouraged. These items may be checked with an operator.

When the Mooney & Sons Circus is on the road, the Jaws Of Death is broken down into nine large wagons for transport. This includes one wagon each for head and tail, one wagon for the neck area (the 10 feet just in front of the furnace), and six for the main body.

Midway Rides

Meril Vill

11th Level Male Human Wizard

STR: 10

INT: 18

WIS: 16

DEX: 9

CON: 11

CHR: 10

AC Normal: 0

AC Rear: 0

Hit Points: 27

Alignment: Chaotic Good

Languages: Common, Elvish, Gnomish, Orcish, Blue Dragon, Red Dragon, Green Dragon, Gold Dragon

Weapon Proficiencies: Dagger, staff

Nonweapon Proficiencies: Engineering (18), leatherworking (18), artistic ability (18), spellcraft (16)

Magic Items: *Bracers of defense AC 0, ring of water walking, ring of warmth, dagger +4, slippers of spider climbing, four scrolls with permanency*

Spells/day: 4 4 4 3 3

Spell Books

Level 1 Spells

| | |
|----------------------------|-------------------------|
| <i>Affect Normal Fires</i> | <i>Alarm</i> |
| <i>Burning Hands</i> | <i>Feather Fall</i> |
| <i>Jump</i> | <i>Phantasmal Force</i> |
| <i>Spook</i> | <i>Unseen Servant</i> |

Level 2 Spells

| | |
|------------------------|------------------------|
| <i>Bind</i> | <i>Blindness</i> |
| <i>Continual Light</i> | <i>Deafness</i> |
| <i>Fog Cloud</i> | <i>Glitterdust</i> |
| <i>Magic Mouth</i> | <i>Whispering Wind</i> |

Level 3 Spells

| | |
|-----------------------|---------------------|
| <i>Dispel Magic</i> | <i>Gust Of Wind</i> |
| <i>Hold Person</i> | <i>Item</i> |
| <i>Spectral Force</i> | <i>Windwall</i> |

Level 4 Spells

| | |
|-------------------------|------------------------|
| <i>Illusionary Wall</i> | <i>Magic Mirror</i> |
| <i>Minor Creation</i> | <i>Rainbow Pattern</i> |
| <i>Vacancy</i> | <i>Wizard Eye</i> |

Level 5 Spells

| | |
|-------------------|------------------|
| <i>Airy Water</i> | <i>Dismissal</i> |
| <i>Fabricate</i> | <i>Passwall</i> |
| <i>Seeming</i> | <i>Teleport</i> |

Appearance: Meril is nearly 70 years old, although the many potions he has drunk through the years keeps him looking about 50. He stands 5'6" tall, has short gray hair, a long gray beard that he often braids, and jet black eyes.

He often dresses in bright blue outfits covered with sequins and other ornaments. He believes this fits in well with his ride and helps draw attention to it.

Background: A native of Daggerdale, Meril spent the first few decades of his adventuring career as a wizard with a band of fighters specializing in dragon slaying. The giant reptiles always fascinated Meril, and he was always more interested in studying the slain creatures rather than counting their treasure. This usually meant that he got a lesser share of the take.

Meril eventually came to understand the operation of a dragon's organs, and is one of the foremost experts in the Realms about the physical makeup of evil dragons.

The wizard joined up with the Mooney & Sons Circus after he watched several performances in Ravens Bluff, where his adventuring band was resting. Meril was tired of wandering through the wilderness looking for dragons to slay, and he wanted to put his knowledge to good use—and at the same time entertain people. Jack Mooney immediately agreed to accept the wizard, in part because a high-level magic user is good protection to a circus traveling on the road.

Meril has been with the circus for four years. He enjoys the atmosphere and the ability to travel. He also likes the work because it brings him into contact with young adventurers. The wizard often hires groups to bring him the skins of evil dragons reputed to be in the area the circus is playing in. Eventually Meril hopes to accumulate enough undamaged skin of the same color that his "dragon" can be given a more realistic exterior.

Tarontuttle's Merry-Go-Round

This brightly-colored attraction is 20-feet in diameter and has a steam organ in the center. As the outer ring rotates, its cams and levers open and close valves on the steam organ, producing a wondrous, loud melody that carries over the midway.

The ride's outer ring consists of two

concentric circular platforms filled with a variety of painted wooden animals, such as griffons, unicorns, and pegasi. There is also a dragon on each platform; the color of the dragons vary weekly according to Tarontuttle's whim with the paintbrush.

Patrons select an animal to ride on. Each animal has a system of wheels, cranks, and cams that make the animal go up and down as the merry-go-round goes round. The wings of the dragons rise and fall in time with the music.

Six horses work in two shifts to provide the motive power for the ride. They are attached to the ride with spokes and harnesses. The horses have become as popular as the ride, and children of all races are rarely short an apple, lump of sugar, or carrot to give them. While Tarontuttle does not encourage the feeding of his horses, he does not discourage children from doing so.

A ride on Tarontuttle's merry-go-round costs one copper piece. The majority of his customers are children. Most adults decline to ride such an outrageous and obviously gnomish device.

Tarontuttle

0 Level Male Gnome

STR: 12

INT: 18

WIS: 18

DEX: 10

CON: 7

CHA: 12

AC Normal: 10

AC Rear: 10

Hit Points: 3

Alignment: Neutral Good

Languages: Common, Elvish, Dwarvish, Gnomeish, Orcish, Circus Jargon.

Weapon Proficiencies: None

Nonweapon Proficiencies: Engineering (18), animal handling (horses) (18)

Appearance: Tarontuttle's youthful looks and build hide his 341 years. The gnome keeps in shape; his 3'4" frame is 78 pounds of muscle and bone. He dresses in bright colors, preferring red and green over other combinations.

Background: Tarontuttle (his real name is much longer and difficult to pronounce) was born curious. A native of Ravens Bluff, he is open and friendly to everyone. His pleasant manner is evident when he calls to circus goers, attempting

Midway Rides

to attract them to his ride.

He especially likes adventurers, and he will swap tale for tale with them for as long as they are willing. He often can be found in the company of adventurers after the circus closes down. If business has been good that day, he buys the refreshments.

Tarontuttle has always considered himself an adventurer at heart and would dearly love to go on one adventure to see what it is like. If the circus is wintering in Ravens Bluff, there is a good chance an adventuring party could coax him away from his ride for a few days out in the wilderness. If Tarontuttle leaves his ride, he will ask Silva Elkwood, Jack Mooney's daughter, to tend it for him.

The Horses

Tarontuttle's horses are characters all by themselves.

Trigger: Male draft horse.

Trigger is the largest of Tarontuttle's horses and the team leader. Despite his size he is very gentle. Trigger is a beautiful jet-black animal who is especially fond of apples and peanuts. The 10-year-old horse adores children and is careful not to nip their hands when they feed him.

Sally: Female draft horse

Sally, a six-year-old dapple gray mare, has had two foals by Trigger. One was sold to a farmer, the other, Dolly, remains with the merry-go-round. Sally is a willing worker. And while she enjoys the company of children, she would much rather be with Trigger. Tarontuttle is careful to keep the two horses on separate shifts. Her favorite treat is toffee apples, however, she tends to eat anything offered by children.

Ned, Tom, and Wilbur: male draft horses

Ned, Tom, and Wilbur are very strong and have similar dispositions. They are hams at heart and love attention, especially from demi-humans. Ned, a 14-year-old chestnut roan, loves apples. Wilbur is a sorrel, eight years old, and has a sweet tooth that makes him partial to sugar. Tom, also a sorrel, is seven. He will only take carrots from strangers, while he will eat nearly anything Tarontuttle provides.

Dolly: female draft horse

Dolly is nearly three years old and Tarontuttle still is training her. She is

excitable, tends to scare children, and must be talked to harshly to calm her down. She loves apples of all kinds, and his dapple gray, like her mother.

Draft Horses

Intelligence: Animal; Alignment: Neutral; AC: 7; Movement: 12; Hit Dice: 3; hp 20 (Trigger), 12 (Sally, Doily), 15 (Ned, Tom, and Wilbur); THACO 17; No. Of Attacks: 1; Damage: 1-3; Size: L.



Midway Vendors

Fortune's Lady

A small black, orange, and red striped tent is the workplace of Jack Mooney's sole fortune teller. The tent sits across from Starbright The Knight and sometimes lures circus-goers who are not able to get into the play because of capacity crowds. The fortune teller draws only 25 to 50 customers a day – perhaps because people believe the fortune teller is a hoax and don't want to waste their coins or because they are afraid of the future.

A small sign near the tent flap reads: "Fortunes Told, Destinies Predicted, Laurinda Borzik Sees All."

Strings of colorful glass beads make up the doorway where patrons enter. Incense is always burning inside the tent, which is decorated with large feathers, silk draperies, and unusual art objects. A small table near the center of the room holds three ornately carved wooden candleholders. A crystal ball sits on a matching wooden stand. A closed off portion of the tent, marked by a black silk tapestry, leads to Laurinda's study.

When a customer enters the tent, Laurinda peers up from behind her crystal ball, her large, brown eyes studying the patron. Many patrons are surprised at Laurinda's age and beauty, picturing fortune tellers as old, ugly women.

Laurinda has no set fees, varying costs from customer to customer. She is a good judge of people and usually can tell how wealthy her customers are. She has been known to charge peasants one copper piece for a glance into the crystal ball, while nobles have had to pay many gold pieces.

After accepting her fee, Laurinda casts a *cantrip*, *phantasmal force*, or other spell, causing the hollowed interior of the crystal ball to fill with pale blue and green smoke. The smoke rises from the ball and circles the customer's head. Additional effects visible inside the crystal ball vary with the spell Laurinda uses. While the smoke begins to clear, Laurinda begins to tell vague forecasts for the customer, such as: "You will meet a tall man who will affect your life," "Mysterious forces are at work all around you – take care where you travel," "Something wonderful is going to happen to you next week," "Romance will enter your life very soon," or "You must change your lifestyle; take more risks and great things will happen."

Laurinda will only perform 15 crystal ball readings a day. She says that is

because the magical energies of the ball will not allow for more. Actually, it is because that is how many spells Laurinda can memorize to create unique effects.

When she has expended her spells – or when patrons want their future told by another means – Laurinda offers tea leaf studies and palm readings. These services will get the patron no better answers than the crystal ball viewing. However, Laurinda's presentation and dramatic predictions satisfy nearly every customer.

If a patron wants more knowledge about the future, and can convince Laurinda that he has a good reason for wanting specific information, she offers to bring out her *fortune telling cards*. However, she warns the patron that the cards could reveal something bad, and he must be willing to deal with the cards' results. Laurinda does not charge for the card reading, even though it is the only accurate fortune-telling source in her tent. She instructs the patron to select a card from the deck. The card becomes three-dimensional and shows a segment of the future.

The study in the back of the tent holds a hammock, supported by the tent's poles. Under the hammock is a chest holding Laurinda's spell books and profits. A small desk holds writing papers, ink, quills, and a jeweled dagger.

New Magic Item

Fortune Telling Cards: Only twelve such decks are known to exist. Each deck starts with 50 cards, and is therefore good for 50 fortunes. A character pulls a card from the deck and rolls 1d12. The number rolled corresponds to the number of months in the future in which the portrayed incident will happen. The card shimmers, becomes three-dimensional, and shows a scene involving the character who pulled card. For example, a card could show the character finding a great fortune, being killed in a battle with a monster, finding his or her true love, or any other scene the DM wishes. The scene is played out before the character for three minutes, then the card vanishes. It is possible to alter the future the card displayed by certain actions; but the card does not reveal what those actions are.

Laurinda Brozik

9th Level Female Human Magic User

STR: 9
INT: 18
WIS: 16
DEX: 17
CON: 10
CHA: 17
AC Normal: 7
AC Rear: 10
Hit Points: 22
Alignment: Chaotic Good
Languages: Common, Elvish, Gnomish, Dwarvish, Halfling, Ogrish, Pixie.

Weapon Proficiencies: Staff, dagger
Nonweapon Proficiencies: Astrology (18), ancient history (17), ancient languages (18), reading/writing (19), spellcraft (16)

Magic Items: Fortune telling cards (four full decks, one deck with 31 cards), dagger +3, Bucknard's everfull purse (silver, electrum, gold type), bag of holding (1,500 lbs size)

Spells/day: 4 3 3 2 1

Spell Books

Level 1 Spells

| | |
|------------------------|--------------------------|
| <i>Audible Glamer*</i> | <i>Cantrip*</i> |
| <i>Dancing Lights*</i> | <i>Detect Magic</i> |
| <i>Friends</i> | <i>Phantasmal Force*</i> |

Level 2 Spells

| | |
|--------------------------|-----------------------------------|
| <i>ESP*</i> | <i>Glitterdust</i> |
| <i>Hypnotic Pattern*</i> | <i>Improved Phantasmal Force*</i> |

Level 3 Spells

| | |
|----------------------------|------------------------|
| <i>Gust Of Wind*</i> | <i>Clairvoyance</i> |
| <i>Illusionary Script*</i> | <i>Spectral Force*</i> |

Level 4 Spells

| | |
|---|-------------------------------|
| <i>Fire Charm</i> | <i>Hallucinatory Terrain*</i> |
| <i>Rary's Mnemonic Enhancer*</i> (<i>Phantasamal Force X3</i>) | |

Midway Vendors

Level 5 Spells

*Advanced Illusion** *Teleport*

* indicates spells memorized each day for her "fortune telling."

Appearance: Laurinda is 30 years old. She has large, brown eyes and thick black hair that falls in spiral curls to her shoulders. She is 5' 5" tall, weighs 105 pounds, and wears scant, colorful clothes that show her curves. She always wears at least three necklaces and many rings and bracelets. About her waist she wears a belt made out of copper loops and coin shapes.

Background: Laurinda, originally from Thesk, joined the Mooney & Sons Circus one year ago after a group of adventurers she was traveling with died in a haunted woods. Laurinda, the only survivor, recovered the spirits' treasure – four decks of magical cards that tell the future. Pulling one of the cards from the deck, Laurinda foresaw her own death – if she continued to adventure.

She immediately changed professions, deciding to capitalize on fortune telling by joining the Jack Mooney & Sons Circus. She has perfected her act through the use of her spells, and she enjoys making up harmless fortunes for customers. She also enjoys appearing aloof, mysterious, and enchanting.

Laurinda only used her magical cards when a customer persuades her why he or she needs to know certain details about the future. These special cases are rare and usually involve adventurers who want to know if their families will be all right while they journey cross-country in search of wealth. In other instances, she has used the cards for city leaders pondering the effect of pending rules or upcoming battles.

Laurinda likes walking through the circus midway and often closes her tent so she can stroll to watch the rides and games and listen to the wandering bards. She packs her wealth and spell books inside her *bag of holding* when taking these jaunts, as she is not too trusting of the circus patrons. On these frequent walks Laurinda hopes to catch sight of Jack Mooney, whom she has become smitten with. She is toying with drawing a card from the deck to see if she has a future with the circus ringmaster.

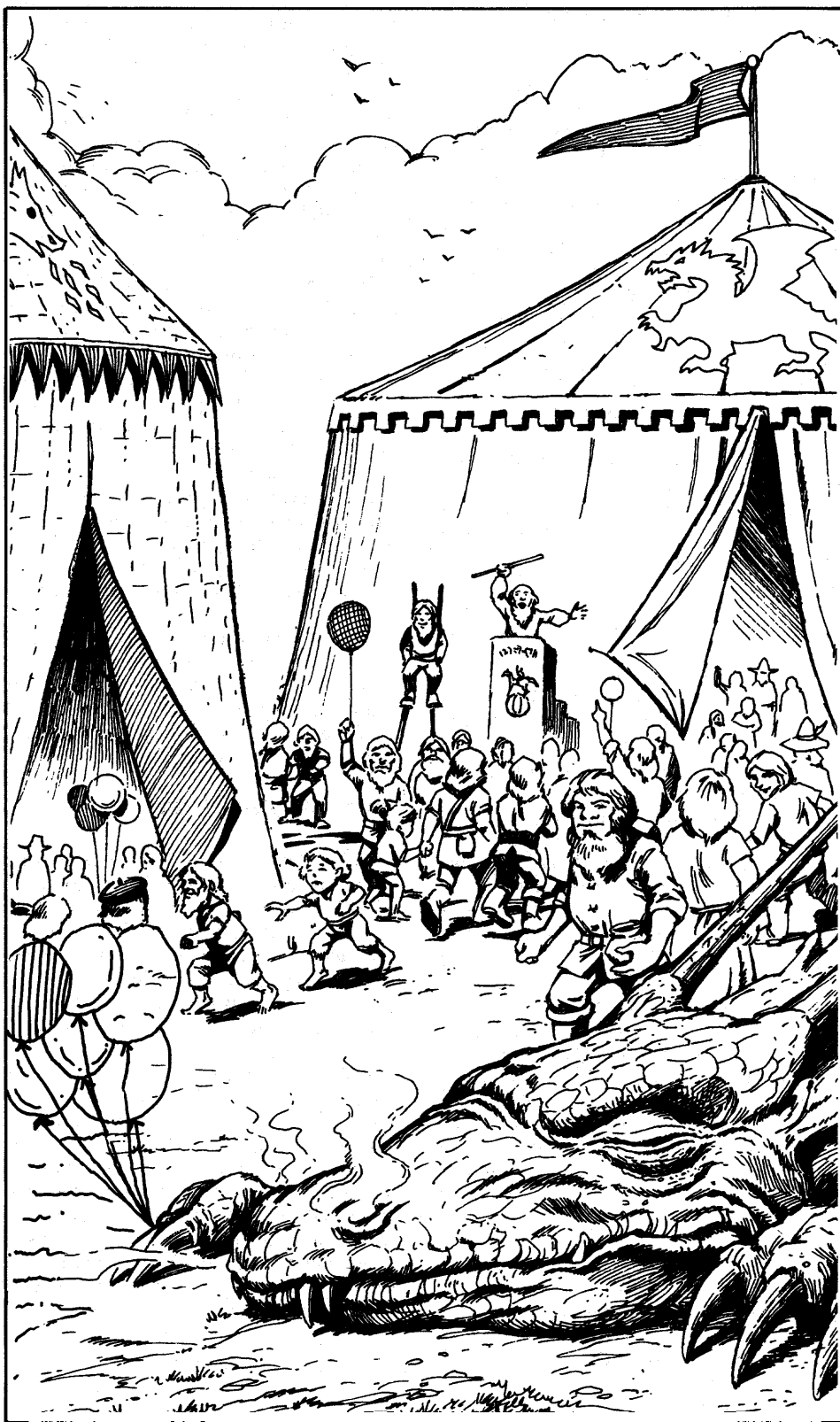

Midway Vendors

Terrific Ts

Operated by the artist Martel Desden and his nephew, Sartan, this shop occupies a small corner in the midway. The merchandise offered is unique to Ravens Bluff and other cities in the Realms. At Terrific Ts customers can buy tunics painted with various pictures and slogans.

Slogans usually deal with the circus in some fashion. Some are general, such as the popular, "Mom and Dad went to Jack Mooney & Sons Circus and all I got was this lousy tunic!" Others are more specific, dealing with acts, "I Saw Doagar the Beholder Tamer at Jack Mooney & Sons Circus"; rides, "I Took the Paladin Plunge" or "I've Done the Dragon Drop"; or personalities, "Bjorn Bears All."

Some tunics boast comments on different aspects of life in the Realms, such as "Serfs Suck," "Life's a Beach," and "There's No Race Like Gnome." Others are targeted at adventurers, such as "My Full Plate Is At The Smith's," "Some Clerics Are Pointless," "Dragon Slayer," "I'd Rather Be Adventuring," and "Wizards Are Weanies." Martel also keeps a few smaller tunics in stock for infants; some of them have such sayings as "Future Mage" and "Wee Warrior."

Martel's favorite tunics are those which display his works of art. He consistently produces beautiful prints on tunics. Some works are humorous, like a tunic painted to resemble a chain shirt. Martel prefers, however, to render noble forms of Realms wildlife, such as unicorns, dragons, tigers, griffons, and falcons. He also takes requests for other creatures, scenes, or portraits.

Martel's prices are reasonable. Slogan tunics on display sell for two gold pieces; tunics with scenes sell for three. Tunics made to order cost four. Martel paints portraits on tunics for five gold pieces. In addition, he also works on other clothing, such as cloaks, belts, and caps. The prices for these vary based on the material involved and the elaborateness of the slogan or design. Although Martel carries a wide selection of sizes and colors of tunics, his stock of other clothing items is relatively limited. Customers wanting a custom slogan on a cloak, might have to provide the garment. The cost for Martel's labor is a minimum of two gold.

Martel Desden

2nd Level Male Human Transmuter

STR: 12
INT: 13
WIS: 18
DEX: 17
CON: 10
CHA: 11
AC Normal: 7
AC Rear: 10
Hit Points: 7
Alignment: Chaotic Good
Languages: Common, Elvish, Dwarvish, Orcish

Weapon Proficiencies: Dagger
Nonweapon Proficiencies: Artistic ability (painting) (19), reading/writing (14), heraldry (13)
Magic Item: *Wand of Color*
Spells/day: 2 + 1 alteration

Spell Book

Level 1 Spells

| | |
|----------------------------|--------------------|
| <i>Affect Normal Fires</i> | <i>Cantrip</i> |
| <i>Color*</i> | <i>Color Spray</i> |
| <i>Erase</i> | <i>Read Magic</i> |
| <i>Unseen Servant</i> | <i>Wizard Mark</i> |

* Martel usually carries two or three *color* spells a day.

Appearance: Martel is 34 years old, stands 5' 8" tall, and weighs 140 pounds. He has brown hair which has begun to turn gray at the temples. His blue eyes are bright and lively. Martel cares little about his own appearance, but usually dresses in loose clothing of bright colors. Blues and greens are his favorite colors to wear. He seldom wears one of his own tunics.

Background: Martel Desden has a natural artistic ability increased by formal training at the hands of a master. He has painted since he was a young man, at first considering it a relaxing hobby. He tried becoming a wizard and was somewhat successful, but he always found himself trying to use magic for artistic purposes.

While exploring an abandoned keep with some companions, he discovered the *wand of color* and a scroll with the *color* spell on it. Considering it an omen of sorts, he gave up the adventuring life and became a professional artist. His sales were sluggish, and he often found himself painting for friends to pass the time. A

few years ago one of his friends asked him to paint a design on a tunic, and the idea for Terrific Ts was born. When Martel visited the circus, he realized that it would be the perfect environment for his pursuits: he could paint all day, earn money at it, and occasionally be truly challenged. Martel asked his nephew to join him so that the stand could be manned while he painted. Martel enjoys his work but sometimes becomes disgusted by the tacky slogans and artwork which sell the best, and he usually refuses to wear any of his own tunics. He tends to be rather terse in dealing with other people. When he receives a special request for a tunic, he asks a few short, incisive questions and then paints.

If the result does not meet expectations, Martel either reluctantly makes changes or tells the customer that he has produced just what the customer asked for.

Sartan Desden

0 Level Male Human

STR: 12
INT: 13
WIS: 14
DEX: 17
CON: 11
CHA: 16
AC Normal: 7
AC Rear: 10
Hit Points: 4
Alignment: Chaotic Good
Languages: Common, Elvish, Halfling, Dwarvish

Weapon Proficiencies: Short sword
Nonweapon Proficiencies: Artistic ability (singing) (14)

Appearance: At 17, Sartan is a tall youth. He stands 6' and weighs 160 pounds. He prefers to wear his black hair long, and it curls down to his shoulders. He is usually well-dressed in a white shirt, gray pants, and a brilliant metallic blue vest with "Terrific Ts" inscribed on the back.

Background: Sartan chose recently to go into business with his uncle, rather than remain on the farm with his parents. He lacks the painting ability of his uncle, and he greatly admires the man's artistic abilities. However, he sometimes wonders about his uncle's business sense. Sartan has a head for business and is very concerned when Martel argues with customers over the artistic value of a tunic.

Midway Vendors

Despite his loyalty to his uncle, he desires to one day become a bard and move on. And he spends much of his free time in discussions with the group of liberal bards who call themselves "Adagio Jones And The Goodwinds."

New Wizard Spell

Color (*Alteration*)

Level: 1

Range: Touch

Components: V, S, M

Duration: Permanent

Casting Time: Special

Area of Effect: 8 square yards

Saving Throw: None

This spell allows a wizard to effect a permanent color change in cloth. The speed at which the change takes place is variable, depending on the thickness of the cloth. With a gesture and a bit of concentration, the caster can make an entire piece change to a single hue. If several colors are desired, the caster must trace with his fingers the areas he intends to color a specific hue. If the wizard wants to add a second color to the cloth, he must cast another *color* spell. Any color or shade may be created, including metallic tints, although these shades do not actually consist of precious metals. The effect is permanent until dispelled.

New Magic Item

Wand Of Color: This item, usable by all classes and races, allows the user to change the color of cloth as the *color* spell. Shaped like a fine painter's brush, the wand allows greater precision than a normal casting of the spell. The wand was created to be easily recharged, and a simple casting of the *color* spell will add another charge, up to the maximum of 100 charges.

Caricatures

Aster the cartoonist has a small shop which is usually placed nearby the other circus artists, Martel of Terrific Ts and Jantz of Portrait Balls. For a price, Aster executes cartoonish portraits of customers. The pictures can be done in charcoal or full color, and in a variety of sizes.

Early in the day, Aster sets up his easel, with a disorganized pile of paper, parchment, and papyrus nearby. Within easy

reach are his charcoal and other pigments, a water basin and towel, a pair of scissors, his cashbox, and a vial of light varnish. The last has a spray mechanism attached and is used to "smudgeproof" his pictures (for an additional fee). A few finished pieces are placed around him to show what he does. While he waits for customers, he often works on cartoon animals to attract the attention of passersby.

Customers can choose a costume and a setting for their portrait, and Aster is quite talented at a number of backgrounds and cartoon creatures. He produces portraits with exaggerated features and expressions, but usually manages to catch the essence of the individual.

Prices are as follows:

| SIZE | BASE COST | | ADDED COSTS | | |
|---------|-----------|-----------|-------------|--------------|------------|
| | Papyrus | Parchment | Paper | Smudge-proof | Full Color |
| 9"x12" | 2 gp | 3 gp | 4 gp | 1 sp | 1 gp |
| 12"x18" | 4 gp | 5 gp | 7 gp | 2 sp | 2 gp |
| 12"x27" | 6 gp | 7 gp | 10 gp | 3 sp | 3 gp |

A small portrait can be finished in fifteen minutes, a medium in twenty-five, and a large in about a half-hour.

Darrin Aster

1st Level Male Human Bard

STR: 11

INT: 13

WIS: 13

DEX: 15

CON: 9

CHA: 15

AC Normal: 9

AC Rear: 10

Hit Points: 5

Alignment: Neutral Good

Languages: Common, Elvish, Halfling, Gnomish

Weapon Proficiencies: Dagger, sling

Nonweapon Proficiencies: Artistic ability (drawing) (14), reading/writing (Common only) (14)

Bard Abilities:

CW DN PP RL

50 20 30 5

Appearance: Aster is 5'8" tall and weighs 188 pounds. He appears chubby and jovial, his green eyes sparkling and blond hair always unruly. He cares little about

his appearance, wearing solid, bland colors which usually appear a smudged gray.

Background: Aster (he despises his first name and refuses to use it) tried his luck as an adventurer, acting as his party's mapper. The wry references and cartoons which appeared on his maps often amused and sometimes annoyed his companions. After a lizardman nearly put a spear through his hand, he decided his cartoons were more important to him than adventure, and he quit his wandering. He was unable to find a large market for his drawings, barely enough to keep himself equipped, until he discovered the circus. The atmosphere encourages customers to like his cartoons, even when they are bitingly satirical. He never much liked music, preferring to exercise his bard abilities through poetry and jokes. As he draws, he constantly talks to his customers, joking and poking fun at anything nearby.

Aster loves the circus life and the people in it, especially his fellow "artists in exile," Martel Desden and Jantz Thozzil.

Adventurers looking for a mapper can be referred to him. He still makes maps for others – for a fee. However, he often tries to talk the customer into a caricature or two, also. The bard is a good source for rumors, as his customers often tell him about what is going on in any given area of the Realms while he draws them.

Midway Vendors

Glitz & Klax's Potions & Elixers

It is the silver tongue of the barker and the nature of the commodities he hawks that bring crowds to Glitz's And Klax's Potions And Philters in the Mooney And Sons Circus midway.

Glitz and Klax specialize in *minor potions*, magical mixtures which have about one-tenth the power of full-strength potions. For example, a *minor potion of growth* causes the imbiber to grow about seven inches; a *potion of treasure finding* will lead the imbiber to dropped coins. Duration of minor potions are half of the full-strength varieties.

A minor potion affects only the imbiber, so circus goers will not be able to obtain anything like a *potion of human control* or a *philter of love*. Likewise, magical oils are not available.

The stand looks like a large wagon from an old medicine show, with the back serving as a stage for the barker's pitch. The wagon is painted with bright reds, yellows, and oranges, and it is always clean. The potion laboratory is toward the inside front of the wagon and is well shielded from the eyes of the public.

The barker is Savilon Glitz, who is frequently aided by a halfling, Simon Kladin. G'Ned Klax is the owner of the operation and is the alchemist who turns out the product.

The pitch begins when Savilon extols the virtues of potions and philters, how they can enhance people's appearance, give them more enjoyment of life, and perhaps bring them wealth. Once a crowd has drawn, which includes a ringer – usually Simon – Savilon asks for a volunteer and selects the ringer. The "volunteer" drinks a normal potion, which is usually growth because that makes Simon look impressive. After viewing the tall halfling, many people in the crowd want to get one of these potions, and Savilon is happy to accommodate them provided they meet the price. Usually before sales begin he points out that potions don't always have the same effect on all individuals. That way he is able to take money with a clear conscience from the rubes.

Cost for the potions and philters range from 10 silver pieces to one gold piece. G'Ned is not the Realms' most organized person, so there is a 5% chance that any potion purchased is actually a full-strength potion.

Minor potions usually available include: *climbing*, *diminution*, *hill giant strength*, *growth*, *invisibility*, *invulnerability*, *treasure finding*, *water breathing*, *beauty*, *rainbow hues*, and *ventriloquism*. G'Ned makes full-strength potions for special clients and some of the circus people.

Glitz's and Klax's are a major source of income for glassblowers during the winter months in Ravens Bluff, and for adventurers anywhere along the circus's circuit who have components to sell or trade for potions.

G'Ned Klax

3rd Level Male Gnome Illusionist

STR: 7

INT: 16

WIS: 14

DEX: 13

CON: 15

CHR: 12

COM: 7

AC Normal: 10

AC Rear: 10

Hit Points: 6

Alignment: Chaotic Neutral (Good tendencies)

Languages: Common, Gnomish, Dwarvish, Halfling, halting Hill Giant, Circus Jargon

Weapon Proficiencies: Staff

Nonweapon Proficiencies: Brewing (16), herbalism (14), reading/writing (16), alchemy (16)

Magic Items: *Periapt of proof against poison*

Spell Book

Level 1 Spells

Audible Glamer
Mending

Cantrip
Phantasmal Force

Appearance: G'Ned Klax is 113 years old, 3'6" tall, and weighs 88 pounds. His eyes are brown, and his balding pate is surrounded by a fringe of black hair liberally seasoned with gray. He acts the part of a grumpy old coot, rarely venturing out of his wagon workshop while the rubes are still lurking about on the grounds. But once the circus is closed he relaxes and enjoys a mug or two of ale beneath the high moon.

Background: G'Ned was born in the High Dale and began his adventuring life as an illusionist. However, he quickly put that

lifestyle behind him after tangling with one too many orcs and nearly losing his life. After traveling for a year he entered the tutelage of the alchemist Carter of Arabel. He learned the trade quickly and took over the business when Carter passed on.

He operated the alchemy shop for 40 years before he met Joshua Kestrel and learned about the Sandmen. By then the gnome had grown bored of the merchant's life and felt like adventuring again. At Joshua's urging he joined the Mooney And Sons Circus, befriended Savilon Glitz, who was working with the Sandmen at the time, and created Glitz's And Klax's Potions And Philters.

G'Ned enjoys his new venture because he gets to see a lot of the country, and he does not feel threatened by monsters because he is confident no orcs or other creatures would attack a group this large.

For such an intelligent individual, G'Ned is extremely absent-minded, and he has taken to writing down almost every thought that strikes him, whether he has any appropriate writing materials handy. The walls of his workshop and living quarters are littered with notes on various topics, and he has been known to use tents, tables, and even other people's clothes for his note taking.

G'Ned is not quick to pass judgment on individuals, however he took a strong dislike to Simon Kladin when the little thief was placed under his direction. His attitudes have softened a little through the past several months, as the halfling has displayed his true talents in mathematics and organization.

G'Ned misplaced one of his spell books, the one remaining contains only first level spells. G'Ned can memorize two first level spells a day; he can't memorize a second level spell because he doesn't have access to spells of those levels. He does not memorize spells on a daily basis – only for special events or as needed.

Midway Vendors

Savilon Glitz

3rd Level Male Half Elf Thief

STR: 13
INT: 14
WIS: 12
DEX: 16
CON: 14
CHR: 18
COM: 16

AC Normal: 6

AC Rear: 8

Hit Points: 13

Alignment: Chaotic Good

Languages: Common, Elvish, Halfling, halting Gnomish, Circus Jargon

Weapon Proficiencies: Dagger, lasso

Nonweapon Proficiencies: Juggling (15), rope use (16), ventriloquism (12)

Magic Items: *Bracers of defense*, AC 8

Thief Skills:

| PP | OL | FT | MS | HS | DN | CW | RL |
|----|----|----|----|----|----|----|----|
| 30 | 15 | 30 | 45 | 50 | 45 | 80 | 25 |

Appearance: Savilon Glitz is 25 years old, is 6' tall, and weighs 172 pounds. He has light blond hair that he wears shoulder length; his black eyes are flecked with silver. He usually dresses in colorful shirts and loose pants. However, toward the end of the circus's stay in a town he begins to wear dark clothes which will make it easier to hide in the event unhappy customers want to discuss their complaints about the potions.

Background: Savilon moves about the circus with cat-like grace, inadvertently frightening many people by coming up behind them.

He was born in Suzail to an abusive and drunken father, Kleth the smith, and an unknown golden elf. Savilon was sold at age five to the criminal Scala, who directed a band of child-thieves who operated in the city's market. Scala taught the young half elf to steal, and by the time he encountered Joshua Kestrel, Savilon was one of the city's best thieves, opting to con his mark into giving away his money rather than stealing it.

However, Savilon found that Joshua was not his normal prey, and eventually had to spill the entire story of Scala's operation and how he had become involved with it. Kestrel made the boy an offer he couldn't refuse – help him shut down Scala's operation or be shut down with it.

No dummy, Savilon chose the former proposition.

Scala was driven from Suzail, and her coffers were emptied to fund an orphanage run by clerics of Helm. That operation birthed the Sandmen, and Savilon traveled as part of the group for about a year and a half before they joined the Jack Mooney And Sons Circus. After he had been with the circus a few months, Savilon felt compelled to try a new career, working with G'Ned Klax.

In his role as a pitchman for Glitz's And Klax's Potions And Philters, Savilon is not above taking money from the truly malicious or uncivil customers, giving them a convenient *potion of delusion* or a flask of good Rashemen jhuild, the firewine.

Savilon does not make friends easily, but he considers his closest friends to be Joshua Kestrel, G'Ned, and Simon Kladin. Savilon secretly adores Jack Mooney's daughter, Silva, but he does not have the confidence to approach her.

Simon Kladin

1st Level Male Halfling Thief

STR: 12
INT: 14
WIS: 11
DEX: 16
CON: 17
CHR: 15
COM: 14

AC Normal: 6

AC Rear: 8

Hit Points: 8

Alignment: Chaotic Good (Neutral tendencies)

Languages: Common, Halfling, Elvish, Dwarvish, Circus Jargon

Weapon Proficiencies: Sap, sling

Nonweapon Proficiencies: Forgery (15), haggling (11), bookkeeping/mathematics (14)

Magic Items: *Ring of protection +2*

Thief Skills:

| PP | OL | FT | MS | HS | DN | CW | RL |
|----|----|----|----|----|----|----|----|
| 50 | 35 | 15 | 55 | 50 | 20 | 55 | 10 |

Appearance: Simon is 17 years old, stands 3'3" tall, weighs 72 pounds, and has short brown hair and deep brown eyes. Simon has a large wardrobe – most of the outfits tattered and worn. He wears a different outfit each day; this helps him appear as a different person each evening Savilon begins pitching the magical wares.

Background: Although he is basically a good person, Simon has a selfish streak, and he is extremely miserly when compared to others of his race. This trait contributes to his appearance, as he is loathe to spend money on new outfits or to have the old ones repaired. Savilon has given up asking Simon to improve his appearance and has come to believe the halfling's attire makes him look more like a common circus goer.

Simon acts as both business manager and bookkeeper for Glitz's And Klax's Potions And Philters, handling the contacts for the thousands of single-quaff vials that the business uses. Further, he tries to buy the best potion ingredients for the lowest possible prices from adventuring parties. He sometimes commissions parties to travel in search of particular components.

The young halfling is also a member of the Sandmen, albeit under protest. Simon was making a meager living forging papers for a group of rogues who operated out of Marsember when he was confronted by Joshua Kestrel and the Sandmen; this event took place on the Sandmen's first circuit with Mooney & Sons. The Sandmen scattered the thieves and their organization, and following their usual procedure placed Simon in an acceptable orphanage. The clerics of Helm who ran the facility contacted Kestrel a month later and told him to come and get the little demon before they were forced to release him back into the streets. The Sandmen adopted the boy to rehabilitate him and give him a legal trade.

Eventually they placed the boy under the guardianship of G'Ned Klax, and the two gained an instant antipathy toward each other. However, the gnome alchemist put the boy to work, and the relationship has warmed.

Simon enjoys the rough side of town, and that is where he tries to go once the circus is closed for the evening. Sometimes these outings are difficult if Kestrel or G'Ned is looking after him.

Simon constantly wears a *ring of protection* he lifted from one of the clerics in the orphanage. He also carries a pouch of marbles and a small bag of metal balls, which he throws on the ground to stop angry citizens who have discovered light purses. Another tactic, which Simon uses as a last resort, is to toss a handful of coppers into a crowd, hoping the hysteria will help him lose his pursuers.

Midway Vendors

Portrait Balls

This small, non-descript business sits at the far end of the midway. Because of its high prices, this small establishment – called Portrait Balls – caters to an exclusive clientele, mostly nobles or adventurers. Customers willing to pay the prices are given a crystal ball containing a portrait of their choice. A two-inch diameter ball costs 25 gp, and a six-inch ball costs 100 gp. A husband and wife team, Jantz and Joli, work the shop.

Customers are met by Jantz, who sells his wares with such lines as, “It’s a small price to pay for an everlasting reminder of your love,” “Only a few gold, and you can look on the Snowflake Mountains every day,” and “Think of what a conversation piece it will be.” The shop carries a few landscapes and portraits of ferocious beasts, but also provides portraits on the spot. When he manages a sale, Jantz calls to his wife, who helps set up backgrounds and costumes.

Once the customer selects the background, Jantz holds a crystalline ball of the appropriate size in one hand and points his *Wand of Portraiture* with the other. With the *wand*, Jantz produces a ball of dim light, one to 10 feet in diameter, centered around the object or person to be in the portrait. He can change the size of the sphere or move its focus at will. Joli checks on the view from all angles to insure a good portrait. With the pronunciation of a final command word, the sphere flashes brightly, and a three-dimensional image from the light sphere is permanently embedded in the ball.

The shop wagon holds a large number of props, such as fake armor and weapons, stuffed animals, and artificial plants (made of wood and cloth). If customers want, they can use these props in the portraits.

Joli’s work area is also inside the shop. Here, she makes bases and frames for the balls, and puts the finishing touches on crystal portraits, such as polishing them until they glisten.

New Magic Item

Wand of Portraiture: Late in their brief adventuring career, Jantz and Joli discovered the *Wand of Portraiture* and a small crystal ball set in an ornately carved wooden case. These items were near the remains of an ancient wizard in an old

tower. The wand showed no signs of use, but signs of research were nearby. With some sage help, they discovered how to operate the wand. It functions by being pointed at the person or object, the command “Ready” causes a sphere of light to leap from the wand, centering at a distance determined by the wizard holding the item. With hand motions and pronunciation of the words “bigger” or “smaller,” the caster changes the size and focus of the ball. A sphere 10’ in diameter or smaller costs only one charge, while spheres up to 100’ in diameter costs two. A ball can be made as large as 1,000’ in diameter with the expenditure of three charges. With the pronunciation of the word “flash,” the caster causes the image surrounded by the sphere to become embedded in a crystalline ball, which the wand wielder must hold in his other hand.

If a crystal ball is not held, the image appears briefly before dissipating, wasting the charge(s).

Worried that the wand would run out of charges, the couple hired a well-known young researcher called Darsson Spellmaker. With the fragmented notes from the site of the discovery, and a great deal of work, Darsson was able to create a reasonable duplicate of the spell, which he calls *Portrait*. The wand is recharged as often as necessary with this spell.

Jantz Thozzil

2nd Level Male Human Wizard

STR: 10
INT: 14
WIS: 12
DEX: 11
CON: 9
CHA: 11
AC Normal: 10
AC Rear: 10

Hit Points: 6
Alignment: Chaotic Good
Languages: Common, Gnomish, Elvish, Centaur

Weapon Proficiencies: Dagger
Nonweapon Proficiencies: Cooking (14), Herbalism (12), Swimming (10)
Magic Items: *Wand of Portraiture*
Spells/day: 2

Spell Book

Level 1 Spells

| | |
|---------------------|-------------------|
| <i>Alarm</i> | <i>Cantrip</i> |
| <i>Detect Magic</i> | <i>Read Magic</i> |
| <i>Sleep</i> | <i>Taunt</i> |

Appearance: Jantz is 31 years old, weighs 150 pounds, and stands 5’ 10” tall. He has sandy brown hair and brown eyes. At the shop, he wears a purple robe to look more wizardly, but he wears more sedate trousers and shirts when off duty.

Background: Jantz never liked adventuring, but was talked into it by his childhood sweetheart, Joli, whom he later married. When they found the wand, he saw an opportunity for easier money and begged Joli to quit adventuring and start a business. When she agreed, he spent his inheritance to research the wand, leaving the couple rather poor. The profits from Portrait Balls has brought them back most of their wealth, however. They have been with the circus for about five years.

Joli

3rd Level Female Human Fighter

STR: 15
INT: 13
WIS: 11
DEX: 12
CON: 13
CHA: 12
AC Normal: 10
AC Rear: 10
Hit Points: 24
Alignment: Chaotic Good
Languages: Common

Weapon Proficiencies: Long sword, long bow, battle axe, dagger, footman’s mace
Nonweapon Proficiencies: Carpentry (15), artistic ability (glasswork) (12), artistic ability (decorating and landscaping) (11), gem cutting (10)

Appearance: Joli is a well-built 27-year-old woman of 150 pounds. She stands 5’8” tall and has blond hair and green eyes. She dresses in trousers and shirts, worn tight so they do not interfere with her craft work.

Background: Joli is a proud, somewhat domineering woman. She has a strong love for the outdoors and for adventure, and she pushed her boyfriend into join-

Midway Vendors

ing her on a few quests. When he asked her to settle down after finding the wand, she resisted at first. After deciding that they could still travel, she agreed. Traveling with the circus satisfies her wanderlust, though she misses the clash of steel and the smell of old treasures. If there is trouble in the circus, she is one of the first into the fray. If anyone were to offer her a fun quest, she would be strongly tempted to take a temporary break from work at the shop. She tries to work in some adventuring while the circus is in winter camp, though she spends most of that time making rough crystal balls to refine and polish while on the road.

Starbright The Knight

Laughter and applause come from beneath the big blue tent flaps of the Starbright the Knight attraction. Yellow, white, and orange stars are stitched to the tent's exterior, making it stand out from its neighboring vendor tents and wagons. As patrons near the tent, the colors seem to shift and the stars appear to dance. It is not an illusion or any special magic; it is the result of fine elven blue silk that moves easily, yet almost imperceptibly, in the breeze. Newcomers to the circus are so enchanted by the outside of the attraction that they want to see what goes on inside.

A young female gnome, dressed in a gown that nearly matches the color of the tent, stands near the entrance beneath a sign that reads "Starbright The Knight, A Play with Feeling." She charges adults two copper pieces and children, one, to enter. She guarantees all customers will enjoy the show or their copper pieces will be refunded.

The tent's seating capacity is 25, however on busy nights the operators allow 10 more to enter if they are willing to stand. A performance lasts 10 minutes.

The house lanterns dim, a harpist plays a brief melody, and the stage curtains pull back for the show to begin. The play briefly covers the life of a young squire turned knight who falls desperately in love with a fair maiden. While the plot is nothing new for theater-goers, the atmosphere of the performance is unique.

As the knight walks through a forest where a gentle rain is falling, the members of the audience feel the rain on their faces. As the knight waits outside a castle

in the snow, the audience gets cold. And in the final moments of the play when the knight faces a fearsome red dragon, the audience smells brimstone, and the air inside the tent becomes warm.

Starbright the Knight is portrayed by an able young actor, and the object of his affections is an actress whose physical beauty far surpasses her theatrical ability. Some of the backdrops are painted scenery, but the majority of the effects such as the rain, cold, and the dragon, are fabricated by the Flintsteele family who run the attraction. The special effects are primarily the results of *phantasmal force*, *improved phantasmal force*, and *spectral force* spells.

The Flintsteeles include Grandmother Martha Tanner; her son, Thouge Flintsteele; his wife, Twig Flintsteele; and their daughter who stands outside the tent, Grace Flintsteele. Grace, a budding thief, is the only member of the Flintsteele family who is not an illusionist.

If patrons complain that the show was not worth the coins paid, Grace cheerfully refunds their copper pieces, notes where they put the coins, and then pickpockets the coins back.

The Flintsteeles also put on special plays, where adventurers and nobles commission a performance of their choice. These performances cost 50 gold pieces per 10 minutes of performance. The price is negotiable if business is slow.

Martha Tanner

10th Level Female Gnome Illusionist

STR: 7

INT: 18

WIS: 16

DEX: 12

CON: 6

CHA: 14

AC Normal: 10

AC Rear: 10

Hit Points: 22

Alignment: Neutral Good

Languages: Gnomish, Common, Elvish, Dwarvish, Halfling, Lizardman, Orcish, Circus Jargon

Weapon Proficiencies: Staff, dagger

Nonweapon Proficiencies: Cooking (19), Seamstress (11), Weaving (17), Herbalism (16), Spellcraft (16)

Magic Items: *Ring of warmth*, *portable hole*

Spells/day: 4 4 3 2 2 plus one illusion per spell level

Spell Books

Level 1 Spells

| | |
|--------------------------|------------------------------|
| <i>Audible Glamer*</i> | <i>Cantrip</i> |
| <i>Change Self</i> | <i>Nystul's Magical Aura</i> |
| <i>Phantasmal Force*</i> | <i>Spook</i> |

Level 2 Spells

| | |
|-----------------------------------|-------------------------|
| <i>Blindness</i> | <i>Blur</i> |
| <i>Fools' Gold</i> | <i>Hypnotic Pattern</i> |
| <i>Improved Phantasmal Force*</i> | <i>Invisibility</i> |

Level 3 Spells

| | |
|--------------------------------|----------------------|
| <i>Invisibility 10' Radius</i> | <i>Phantom Steed</i> |
| <i>Spectral Force*</i> | <i>Wraithform</i> |

Level 4 Spells

| | |
|------------------------------|-------------------------------|
| <i>Fear</i> | <i>Hallucinatory Terrain*</i> |
| <i>Improved Invisibility</i> | <i>Vacancy*</i> |

* indicates spells memorized each day for the performance.

Appearance: Martha is tiny even for a gnome, standing 2 1/2' tall and weighing 42 pounds. She is 150 years old, has shiny white hair, and twinkling brown eyes. She dresses in grays and browns to help her blend into the shadows backstage.

Background: Born to a merchant family near Hillsfar, Martha learned all the female graces early on – cooking, sewing, and other domestic tasks. She married young to an illusionist who taught her spells. She learned them only to please him, as she had no real desire to be anything other than a housewife. Unfortunately, her husband wanted something more than a woman who doted on him and had no desire to have a career or hobbies of her own. So he left her after their son, Thouge, was old enough to walk. In a rage, Martha discarded her married name of Flintsteele, and set off on her own.

Heartbroken and frightened, Martha sought work to help support herself and Thouge. She was quickly taken in by a Hillsfar wizard in need of a housekeeper. The wizard, sensing a magical aptitude in the woman, began teaching her more illusionist spells. This time Martha was interested, and she quickly advanced through the magical ranks.

When the wizard died, Martha was

Midway Vendors

once again on her own. Thouge, who had been learning spells from his mother, had fallen in love with a young gnome illusionist and planned to be married. However, Thouge did not want to leave Martha on her own, so he sought an avenue where the family could stay together. That avenue was the Mooney & Sons Circus, where Martha and Thouge devised Starbright The Knight.

Martha enjoys the circus. It affords her the opportunity to use her spells to entertain people and gives her plenty of time to cook, sew, and pick up after her family. She loves Twig as if she were a natural daughter, and she is fond of the impetuous Grace. However, she disapproves of Grace's headstrong manner and is quick to scold any adventurers who take time to chat with her granddaughter.

When the circus is closed or on the road, Martha enchants scrolls with *phantasmal force* spells to aid in the performances.

Thouge Flintsteele

5th Level Male Gnome Illusionist

STR: 14
INT: 17
WIS: 12
DEX: 17
CON: 14
CHA: 12
AC Normal: 7
AC Rear: 10
Hit Points: 14

Alignment: Neutral Good
Languages: Gnomish, Common, Elvish, Dwarvish, Halfling, Circus Jargon

Weapon Proficiencies: Dagger
Nonweapon Proficiencies: Herbalism (10), spellcraft (15), carpentry (14), tailor (16)
Magic Items: *Bag of holding* (250 lbs size)
Spells/day: 4 2 1 plus one illusion per spell level

Spell Books

Level 1 Spells

| | |
|------------------------|--------------------------|
| <i>Audible Glamer*</i> | <i>Cantrip*</i> |
| <i>Change Self</i> | <i>Phantasmal Force*</i> |
| <i>Spook</i> | <i>Ventriloquism</i> |

Level 2 Spells

| | |
|-----------------------------------|-------------------------|
| <i>Blur</i> | <i>Hypnotic Pattern</i> |
| <i>Improved Phantasmal Force*</i> | <i>Invisibility</i> |

Level 3 Spells

| | |
|------------------------|-------------------|
| <i>Spectral Force*</i> | <i>Wraithform</i> |
|------------------------|-------------------|

* indicates spells memorized each day for the performance.

Appearance: Thouge is 98 years old, stands 3' tall, and wears his coal black hair so short it resembles beard stubble. He has large brown eyes, a string-thin mustache that dangles several inches below his chin, and overlarge ears that help give him a comical appearance. He prefers to dress in browns, blacks, and grays to keep his mother happy.

Background: Thouge is very loyal to his mother and admires her because of all the hardships she tells him she has weathered. He has no plans to take his family away from her while she lives. He believes she is a good influence on his young daughter, and he appreciates that she takes care of the majority of the family domestic chores.

Thouge enjoys the circus life because it gives him an opportunity to use his illusionist spells without adventuring. He has heard horrid tales from his mother about the perils and dangers adventurers face and that adventurers have short lifespans. He worries that his daughter will follow that path, and he does everything possible to keep her interested in the circus and their sideshow.

Thouge's greatest love in life is Twig, who he adores because of her abilities, courage, and humor. Each week he brings her a special treat, whether it is flowers, candy, or a trinket he won from a midway vendor.

Twig Flintsteele

6th Level Female Gnome Illusionist

STR: 12
INT: 16
WIS: 14
DEX: 17
CON: 8
CHA: 15
AC Normal: 5
AC Rear: 8
Hit Points: 13

Alignment: Chaotic Good

Languages: Gnomish, Common, Elvish, Dwarvish, Centaur, Goblin, Circus Jargon

Weapon Proficiencies: Staff, dagger
Nonweapon Proficiencies: Astrology (16), engineering (13), fishing (13)
Magic Items: *Ring of protection +2, dagger +2*
Spells/day: 4 2 2 plus one illusion per level

Spell Books

Level 1 Spells

| | |
|------------------------|--------------------------|
| <i>Audible Glamer*</i> | <i>Cantrip*</i> |
| <i>Charm Person</i> | <i>Detect Magic</i> |
| <i>Friends</i> | <i>Hypnotism</i> |
| <i>Identify</i> | <i>Phantasmal Force*</i> |
| <i>Sleep</i> | <i>Spook</i> |
| <i>Taunt</i> | <i>Ventriloquism</i> |

Level 2 Spells

| | |
|-----------------------------------|----------------------------|
| <i>Bind</i> | <i>Detect Invisibility</i> |
| <i>Deeppockets</i> | <i>ESP</i> |
| <i>Forget</i> | <i>Hypnotic Pattern</i> |
| <i>Improved Phantasmal Force*</i> | <i>Mirror Image</i> |
| <i>Misdirection</i> | <i>Ray of Enfeeblement</i> |

Level 3 Spells

| | |
|----------------------|------------------------|
| <i>Clairaudience</i> | <i>Clairvoyance</i> |
| <i>Hold Person</i> | <i>Spectral Force*</i> |
| <i>Suggestion</i> | <i>Wraithform</i> |

* indicates spells memorized each day for the performance.

Background: Twig is a young-looking 90-year-old who at 3'9" is tall for a gnome. She is trim, hence her name, weighing 62 pounds. She has dark red hair that she piles loosely on top of her head, forest green eyes, and a soft, melodious voice that Mooney roustabouts never tire of listening to. Twig is proud of her appearance and likes to be seen, wearing colorful silk dresses and capes to help draw attention to herself.

Background: A native of Dilpur, Twig ran away from home while she was very young to pursue an adventuring life. She joined an adventuring company and was put in charge of caring for the horses and equipment. In lieu of payment, the group's illusionist taught her spells. After a few years Twig had enough magical

Midway Vendors

power to join the others on trips into ruins. Twig loved the work because it was risky and made her feel alive.

However, her adventuring career came to an end when the group decided to rest for a few days in Hillsfar, where she met Thoug and fell instantly in love. She agreed to marry him, fully believing she could pull him away from his mother and make an adventurer out of him. That never came to pass, and Twig was forced to accept the life of a home-bound wife and mother. She believes joining up with the Mooney & Sons Circus is the only thing that saved her sanity. Being with the circus allows her to travel, talk with adventurers, and use her spells – even if it is only to entertain.

Twig tolerates Martha, and on the surface treats her with respect. She continues to love Thoug, although she would leave him and resume an adventuring career if Grace were not so young and still at home. When Grace gets older and leaves, Twig likely will leave, too. Twig believes Grace is her greatest accomplishment. She is proud that the young gnome had the courage to choose her own profession – despite it not being quite legal. And she secretly hopes the girl will tire of circus life and find a good adventuring band to join. To this end, Twig eyes obvious adventuring parties and introduces them to her daughter.

Grace Flintstele

2nd Level Female Gnome Thief

STR: 8
INT: 16
WIS: 14
DEX: 18
CON: 18
CHA: 16
AC Normal: 6
AC Rear: 10
Hit Points: 16
Alignment: Chaotic Good
Languages: Gnomish, Common, Elvish, Halfling, Circus Jargon

Weapon Proficiencies: Dagger, sling
Nonweapon Proficiencies: tumbling (18), tightrope walking (18), gaming (16)

Thief Skills:

| PP | OL | FT | MS | HS | DN | CW | RL |
|----|----|----|----|----|----|----|----|
| 65 | 45 | 30 | 45 | 35 | 35 | 55 | -- |

Appearance: Grace takes much of her looks from her mother. At 40 years old, the young gnome stands 3'4" tall, weighs 61 pounds, and has green eyes and long red hair that she braids and wraps around her head. Grace refuses to wear dark, somber colors – as that would be following her grandmother's wishes. She dresses in blues, greens, and reds, preferring the elvish silk that the tent is made of.

Background: Grace has lived a third of her life in the circus. She revels in all the wonderful sights and sounds and often fantasizes about performing with the aerialists under the Big Top. She learned thieving skills from Bithlain Lightfoot, who works with The Talking And Singing Owlbear act; and she practices daily by retrieving copper pieces from patrons who demand their money back.

On one such "retrieval" several months ago Grace pickpocketed two unusual stones. She keeps these as good luck charms. One stone actually is a *stone of good luck*. The other is a *stone of controlling earth elementals*. Unbeknownst to Grace, the stones belonged to a chaotic evil necromancer who has been looking for them. The wizard has traced their disappearance to the Mooney & Sons Circus. It is only a matter of time before he searches the circus to reclaim them.

Despite her attachment to the circus, Grace intends to leave it soon and start a life of adventuring – inspired by her mother's adventuring tales. She knows her mother approves, as she has introduced adventurers to Grace. However, Grace is biding her time, waiting for that special group where she will fit in, find excitement, and make a name for herself in the Realms.



Midway Vendors

Living Tattoos

Living Tattoos is a vendor in the midway which is popular among adventurers, sailors, and youths from middle class families.

The proprietor is Flame Groth, a pleasant-mannered female dwarf who runs the business out of her large wooden wagon.

Flame specializes in two kinds of tattoos – those put on a person's skin with dyes and several different-sized needles, and those that are magical and that move.

A normal tattoo costs between 5 silver pieces and 20 gold pieces, depending on the size of the tattoo and how involved the design is. Among the most popular designs are flowers, lightning bolts, hearts with initials in them, birds, names, anchors, and insects, particularly butterflies. When the circus is wintering in Ravens Bluff, Flame is kept busy tattooing ravens in various poses on the arms of city guards. Because Flame is a talented artist, she can generate almost any design requested.

Magical tattoos range in price between 100 and 600 gp depending on the size and design. Only adventurers and those from the upper class can afford these tattoos. Flame is careful not to let her customers know she puts these designs on with a special needle, she lets them believe the dyes are magic. Flame's dyes are, however, very expensive, and she uses only the best for her magical tattoos.

Some samples of living tattoos are:

A dragon that flies about on a limb, such as up and down an arm.

Ivy that writhes, growing and twisting around a limb.

Lips kissing and then opening to reveal fangs.

A heart that beats.

A wave that breaks against a shore and then recedes to reveal moving sea life.

Various fireworks.

A candle flickering.

A moving waterfall with birds flying above it.

An hourglass that can be made to tell time.

A snake biting the wearer's arm with blood trickling out of the wound.

A spider building a web.

A small window where the sky changes from night to day.

Flame's studio is in the back of her wagon, and she always opens it during circus hours so the public can watch her

apply tattoos; this helps to increase her business. The wagon is painted red with gold trim. A sign on top of it is lit by a *continual light* spell and reads: Living Tattoos by Flame.

The doors to the wagon are large, big enough to allow humans to comfortably fit through. A curtain of amber glass beads separates her living quarters from her studio. Flame has her customers sit in a comfortable reclining chair, while she sits on a small wooden stool to work on them.

A portrait of a heavily armored black man fighting a gynosphinx hangs on the wall of her studio. She painted this several years ago, and despite numerous offers for it, she has not been able to part with it. Also in the studio is a comfortable sofa that will fit up to three humans. She lets people who are waiting to be tattooed sit there.

Inside her residence is a large red and gold rug that is old and damaged. At one time it was worth several hundred gold pieces. Also inside is a walnut dresser and chest, both always locked. Flame wears the keys to them on a leather circlet about her neck. The dresser contains her clothes and tattooing supplies; the magic needle is kept in a secret compartment in a drawer. The chest contains assorted art supplies, mirrors, combs, china, various gems, and gold and glass beads. Flame is so fond of gems and baubles that she trades tattoos for them. A painting of Flame and her human mentor hangs in a silver frame in her living quarters. She also has several momentos from her years with him stored in a chest under her bed – a toothbrush, half-used bar of soap, scissors, small knife, candles, four sketchbooks, three wooden goblets, and an hour glass. Also in her quarters are more than five dozen books on assorted subjects. She uses these for reference when designing tattoos.

There is a small trapped iron box hidden in the left arm of the sofa in her workshop. This contains Flame's best jewelry and gems – nearly 15,000 gp worth.

Flame Groth

Dwarf female 2nd level fighter

STR: 16

INT: 14

WIS: 10

DEX: 17

CON: 16

CHR: 9

COM: 9

AC Normal: 3

AC Rear: 6

Hit Points: 16

Alignment: Lawful Neutral

Languages: Dwarven, Common, Circus Jargon

Weapon Proficiencies: Hand axe, dagger, short sword

Nonweapon Proficiencies: Tattooing (18), weaving (13), artistic ability (10)

Magic Items: *Needle of lively tattoos, leather armor +2*

Appearance: Flame Groth is a 140-year-old mountain dwarf who is 3'10" tall and weighs 125 pounds. She has long white hair that she braids into rings around her head. She also braids her long white beard, twisting beads and baubles into each braid.

Background: Flame grew up in a small circus hundreds of miles away from Ravens Bluff. She has no idea who her parents were, and considered the circus her only family. She was raised by a human male tattooist, and she apprenticed under him, learning how to wield a tattoo needle and a variety of weapons. After her mentor died, she spent several years moving from circus to circus, and joined up with Jack Mooney when the small circus she was with was sold to Mooney.

Her mentor taught her the art of creating living tattoos. The secret is in a magic needle, which is rumored to be a thousand years old and had been passed down through her mentor's family. When its command word, "couleur" is spoken, it will inscribe animated tattoos.

Flame is fond of her art, and when business is slow she tattoos some of the circus employees. She does this as much to show off her skill as to keep herself busy. Although a loner, she enjoys the company of the Mooney troupe. Her best friends are Bjorn The Bear Wrestler and Ben Hakerty. She spends many evenings with them quaffing jugs of ale and telling old circus stories.

Midway Vendors

New Magic Item

Needle of Lively Tattoos: This is a long, thin adamantium needle with an ivory handle and finger grips. It allows any character with the artistic ability proficiency to inscribe beautiful tattoos onto living creatures with a successful proficiency check. If the check fails, the tattoo still is inscribed, but is obviously flawed in some way.

If the wielder actually has a tattooing proficiency, he can inscribe tattoos with a +2 bonus to the proficiency number, and any roll five or more less than the base number for success results in a tattoo that is a true work of art.

A skilled tattooist also can attempt a magical, living tattoo once a day. If the proficiency check fails, the tattoo looks fine, but has no special properties. Successful magical tattoos become animated, generally behaving just like small, permanent *programmed illusions*. Although a magical tattoo cannot leave the area of the body it was inscribed on, it can move around or perform various preordained functions on that area. Changing designs are done by overlaying a series of animated tattoos and require a separate proficiency roll for each layer. If one layer fails, the entire tattoo becomes non-magical. If the wielder also has the artistic ability proficiency, he may add +1 to the proficiency number, and if the inks used in the tattoo are magical or especially fine (costing at least 100 gp an ounce), the tattooist can add +2 to the proficiency number. Both bonuses are cumulative.

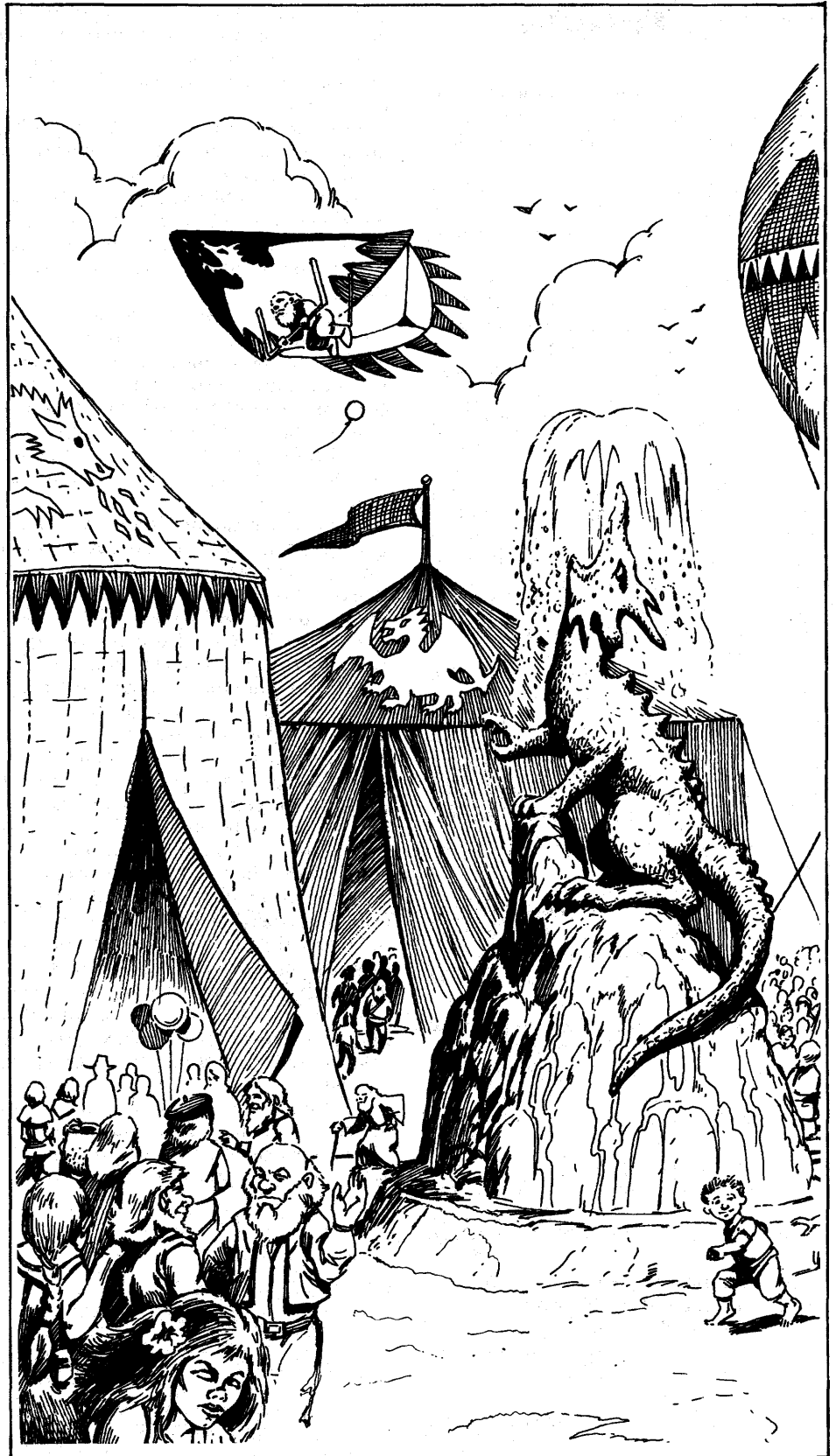

Midway Vendors

Piper's Song Pest Control Agency

Rats are one of the biggest problems facing any outdoor gathering in the Forgotten Realms. The Mooney & Sons Circus is no exception. The crowds, garbage, and hiding places make it an ideal breeding place for various rodents.

Enter the Piper's Song Pest Control Agency: Hamlin the bard, Squeaky the magic-using rat, and Shazgrap the wererat. These three unusual individuals have an equally unusual way of controlling the rat population. Instead of traps, poisons, and what-not, they turn the rats into a weekly show.

Early in any given week that the circus is in a town, Hamlin serves as a wandering musician and juggler. Toward the end of the week, however, he uses his magical *pipes of the sewers* to summon any rats that may have gathered on the circus grounds. He parades them about the circus, under the control of his pipes. Squeaky and Shazgrap assist with various special effects. For example, Squeaky often puts a *cantrip* spell into effect, and Shazgrap uses her *ring of mammal control* to get some of the rats to perform tricks. The entire procession takes roughly half an hour and is especially entertaining for the children.

After the parade, Hamlin marches the rats off the grounds. Squeaky casts *teleport*, taking the rats to an unpopulated area and returning via his *ebony fly*. Squeaky has several such areas memorized, and changes them periodically.

Hamlin

5th Level Male Human Bard

STR: 11

INT: 16

WIS: 13

DEX: 18

CON: 13

CHA: 17

AC Normal: 3

AC Rear: 7

Hit Points: 19

Alignment: Neutral (Good tendencies)

Weapon Proficiencies: Short sword, dagger, staff

Nonweapon Proficiencies: Juggling (17), tumbling (18), animal training (rats) (12), singing (17), pipes (17), harp (17), drum (17) tightrope walking (18), disguise (16)

Languages: Common, Elvish, Circus Jargon

Magic items: *Pipes of the sewers*, *ring of protection +3*, *hat of disguise*

Spells/day: 31

Thief Skills:

CW DN PP RL

50 20 50 55

Spell Books

Level 1 Spells

Cantrip
Charm Person
Detect Magic

Phantasmal Force
Read Magic
Ventriloquism

Level 2 Spells

Continual Light
ESP
Knock

Levitate
Web
Wizard Lock

Appearance: Hamlin stands 5'11" tall and weighs 155 pounds. He has brown hair and gray eyes. He is slightly color-blind, and his choice of wardrobe reflects this. He almost always dresses in blues and grays. He is frequently seen wearing a broad-brimmed hat, his *hat of disguise*, which rarely matches his outfits.

Background: Hamlin was born in a small village near Myth Drannor. The proximity of the city had an effect on the youth; he became fascinated with all the magic there. At the age of 16, he joined an adventuring party, eventually becoming a bard when he could not find a wizard who would accept him as an apprentice.

However, all the party recovered was knowledge about lands around Myth Drannor; treasure always seemed to escape the group. After one particularly disastrous adventure, in which the party's wizard was turned into a rat, Hamlin decided to search for gainful employment. The rat, who now referred to himself as Squeaky, and who retained the ability to talk, stayed with Hamlin.

Hamlin feels sorry for Squeaky, but thinks the wizard would not be a rat if he would have accepted Hamlin as a student. Hamlin never mentions this to the rat, however.

Adventure seemed to follow the pair. During their travels they came across a colony of wererats, which made them prisoners. However, one of the wererats

(Shazgrap) had somehow fallen in love with Hamlin, and helped the pair escape. From that time on, she has accompanied them in their journeys.

Eventually, the trio encountered the Mooney & Sons Circus. Seeing an opportunity, they formed the Piper's Song Agency on the spur of the moment. Jack agreed to try them out, and they soon proved their worth to the management, becoming full-time circus employees.

Hamlin is basically out for himself. He is very loyal to his friends, however, and has a soft spot in his heart for small children. He enjoys music for the sake of music, and often can be found playing his favorite instrument, the pipes, when he is alone. He enjoys the atmosphere of the circus, and he will not willingly join an adventure that would take him away from the circus life.



Midway Vendors

Squeaky The Wonder Rat

Formerly *Skibex Greycloak*
10th Level Male Rat Magic- User

STR: 3
INT: 18
WIS: 10
DEX: 18
CON: 14
CHA: 10
AC Normal: 6
AC Rear: 10
Hit Points: 23
Alignment: Neutral
Languages: Common, Neutral

Weapon Proficiencies: Dagger, staff
Nonweapon Proficiencies: Direction sense (11), reading/writing (19), spellcraft (17), engineering (15), astrology (18), set snares (17), blind-fighting, ancient history (17)
Magic Items: *Ebony fly*
Spells/Day: 4 4 3 2 2

Spell Books:

Level 1 Spells

| | |
|----------------------------|-------------------------|
| <i>Affect Normal Fires</i> | <i>Phantasmal Force</i> |
| <i>Alarm</i> | <i>Shield</i> |
| <i>Armor</i> | <i>Spook</i> |
| <i>Audible Glamer</i> | <i>Ventriloquism</i> |
| <i>Can trip</i> | <i>Read Magic</i> |
| <i>Charm Person</i> | |

Level 2 Spells

| | |
|------------------------|-----------------------|
| <i>Blindness</i> | <i>Know Alignment</i> |
| <i>Blur</i> | <i>Mirror Image</i> |
| <i>Continual Light</i> | <i>Misdirection</i> |
| <i>Fog Cloud</i> | <i>Pyrotechnics</i> |
| <i>Knock</i> | <i>Web</i> |

Level 3

| | |
|---------------------|-----------------------|
| <i>Blink</i> | <i>Spectral Force</i> |
| <i>Dispel Magic</i> | <i>Suggestion</i> |
| <i>Feign Death</i> | <i>Fly</i> |

Level 4 Spells

| | |
|-----------------------|------------------------------|
| <i>Charm monster</i> | <i>Extension I</i> |
| <i>Dimension Door</i> | <i>Improved Invisibility</i> |
| <i>Emotion</i> | <i>Polymorph Self</i> |

Level 5 Spells

| | |
|------------------|--------------------|
| <i>Cloudkill</i> | <i>Telekinesis</i> |
| <i>Teleport</i> | |

Appearance: Squeaky appears to be a normal brown rat, although he is a little on the large side. In his human form, he stood 5'10" and weighed 145 pounds. He had brown hair and green eyes, and dressed in standard magic-user apparel. Now he never bothers with clothes.

Background: Squeaky the Wonder Rat was originally Skibex Greycloak, a magic-user of some accomplishments. While on an adventure, he sampled a *potion of delusion*, shortly after drinking a *potion of polymorph* and assuming the form of a rat. The two potions reacted strangely; as a result, Skibex is now permanently trapped in the body of a rat, and he believes that he always has been a rat.

Being a rat has given Squeaky (as Skibex now chooses to call himself) some problems. While he can talk, thanks to a *limited wish* spell, he has trouble with somatic components (paws aren't like hands). Because of this, any spell with a somatic component has a 20% + 5% per level chance of failing when squeaky casts it. In addition, his new form is not well suited to carrying material components; he almost never memorizes spells which have material components.

Squeaky holds both of his companions in very high regard. He often can be found roaming about the circus grounds — usually in their company. Most of the circus employees recognize him as Hamlin's "pet rat," due to a golden collar he wears, and do not bother him.

Squeaky is able to use weapons. He has a sharpened nail, which he wields like a dagger, causing 1-2 points of damage. A stick operates like a staff and causes 1 point of damage.

Shazgrap

3rd Level Female Wererat Thief

STR: 8
INT: 13
WIS: 9
DEX: 18
CON: 13
CHA: 16
AC Normal: 4
AC Rear: 8
Alignment: Chaotic Neutral (Good tendencies)
Languages: Common, Wererat, Circus Jargon

Weapon Proficiencies: Short sword, dagger
Nonweapon Proficiencies: Tumbling (18), juggling (17), blind-fighting

Thief Skills:

| | | | | | | | |
|-----------|-----------|-----------|-----------|-----------|-----------|-----------|-----------|
| PP | OL | FT | MS | HS | DN | CW | RL |
| 70 | 40 | 25 | 35 | 30 | 30 | 60 | -- |

Magic Items: *Ring of protection +2*, *dagger +1*, *+2 vs smaller than man sized*, *ring of mammal control*

Appearance: In her rat form, Shazgrap appears as a normal gray rat, wearing a collar similar to Squeaky's. In her human form, she is an attractive redhead, who is 5'4" tall and weighs 100 pounds.

Background: While on one of their less successful adventures, Hamlin and Squeaky were taken captive by a tribe of wererats, of which Shazgrap was a member. Hamlin and Squeaky were rescued from this predicament by Shazgrap, who had never quite fit in with the tribe because of her chaotic nature. Since that time, she has accompanied the two.

Shazgrap is not above a little petty larceny now and then, but she will not willingly endanger her friends through her actions. She is in love with Hamlin, but lacks the courage to tell him so (Squeaky has figured it out, but he feels it best to stay out of such matters). Shazgrap normally prefers negotiating or running rather than fighting, but she will become quite fierce if Hamlin is endangered.

Midway Vendors

The Sandmen

The Sandmen's presence has been felt in nearly every spot the Jack Mooney & Sons circus has played. The Sandmen are a group of former warriors, con-men, and researchers who have joined the circus because they believe it affords them a good opportunity to help children.

The Sandmen include Joshua Kestrel, Thurgh, Castron the Storyteller, Savilon Glitz, G'Ned Klax, and Simon Kladin. While they perform their various tasks and acts at the circus, they watch the passing crowds for children who show signs of neglect or abuse. The group knows that they cannot help all the children, so they look for the most severe cases.

When someone spots a potential case, Simon is summoned from his work at the philter stand, and he follows the child. If the child has no home, the Sandmen find a reputable orphanage or similar organization in town and take the child there. If none exists, they temporarily adopt the child and place the waif in good hands at the next stop. In some cities where orphans have no place to go, the Sandmen talk with the local clerics and try to help them set up a facility for them.

The Sandmen fund orphanages from the sales of Klax's most powerful potions and from treasure that Joshua saved from his adventuring career.

If a followed child has a home, the Sandmen wait until nightfall and observe the family to see if the child is abused or neglected. If either is the case, Castron uses his illusions to form the image of a monstrous sandman and warns the parents to take care of the child or a horrible fate will befall them.

The Sandmen continue to watch the family for the next few days the circus is in town, and if the child continues to be neglected or abused they kidnap the youngster and place him or her with an orphanage in a nearby town. The Sandmen have been doing this for the past few years and have not been caught.

If the followed child simply belongs to a poor family, the Sandmen leave packages containing clothing and a few gold pieces.

In any case, the Sandmen leave a calling card – a small green pouch filled with sand.

The Sandmen have no official status as an organization with the circus, although Mooney is aware of their doings. Mooney has told the Sandmen he will deny any knowledge of their operation if a law

enforcement agency comes to the circus asking about missing children.

It is possible player character adventurers could learn of the Sandmen. In this case the group will ask the characters to join them. If the characters decline, the Sandmen try to exact a promise from the characters that they will not reveal the Sandmen's operation.

Joshua Kestrel

Male Human Thief/Fighter Level 5/4

STR: 16

INT: 14

WIS: 13

DEX: 17

CON: 15

CHA: 15

AC Normal: 2

AC Rear: 5

Hit Points: 35

Alignment: Neutral Good

Languages: Common, Dwarvish, Elvish, Hill Giant, Halfling

Weapon Proficiencies: Hand crossbow (specialized), dagger, lasso, long sword
Nonweapon Proficiencies: Blind-fighting, disguise (14), rope use (17), tightrope walking (17)

Magic Item: *Bracers of defense AC 5*

Thief Skills

PP OL FT MS HS DN CW RL
25 20 15 75 75 45 85 45

Appearance: Joshua Kestrel was born Jacob Whitemane, the son of the ranger Sideil and Kendra Whitemane who lived outside of Waterdeep. He adopted the name Joshua when his parents were killed by a dimension-hopping, extra-planer being. The boy, who was 12 at the time, didn't want to share the same fate. Now he is 35 years old, stands 6'6" tall, and weighs 210 pounds. He has green eyes and blond hair, although his hair always looks jet black because he dyes it to further his change in identity.

Background: Joshua is the head night watchman for the circus. His other position is as a member of the secret organization, the Sandmen.

After his parents' death, Joshua wandered in the woods, surviving by his wits for six years until he signed on with a mercenary band, Satryn's Circle, and traveled through the Realms.

He remained with the group for almost a decade, improving his fighter skills, changing profession to a thief, and slowly growing weary of bloodshed. He always grieved over the innocents who were destroyed for the sake of a mercenary's fee. The turning point in Joshua's life came after an assault on a family of hill giants in the forested hills east of Neverwinter. He was told to make sure none of the giant children escaped, "so the vermin wouldn't spread." As he was ready to deal the death blow to a young giant who was only slightly shorter than himself, he looked into the child's eyes and decided he had enough.

Joshua managed to get the child out of the lair and away from the mercenaries. He adopted the giant, named Thurgh, and continued to travel throughout the Realms, this time avoiding civilized areas. He tutored Thurgh in the Common tongue and in human customs. He raised the giant to be kind and good.

Joshua surfaced a few years later in Suzail, shutting down a child-thievery ring. It was here that he gained the first of his Sandmen, Savilon Glitz, who was originally part of the ring's operation. He also made the acquaintance of the gnomish alchemist, G'Ned Klax, who also joined his loosely-knit organization. Joshua and his company joined the Mooney & Sons Circus shortly thereafter.

In the past several years Joshua has suffered from insomnia. Although he considers it a curse, he also is thankful for it because it gives him more waking hours to work at the circus and operate as a Sandman.

To the casual observer, Joshua appears remarkably grim, never in good humor. Those who know him well, however, realize that he loves the circus and children.

Joshua considers himself a friend of children of all races. He believes children are the Realms' only hope for stemming the tide of evil he sees washing over the land.

Joshua shares a large wagon with Thurgh and Castron Salizar, the storyteller. He can usually be found wandering the circus grounds.

Midway Vendors

Thurgh

Hill Giant Roustabout

Intelligence: Average (8-10)

Alignment: Neutral Good

Armor Class: 5

Hit Dice: 9

Hit Points: 45

No. Of Attacks: 1

Damage: 2-16 (rocks), 2-12+7 (club, sword)

Size: L (11' tall)

Languages: Common, smattering of Halfling, Gnomish, and Hill Giant

Weapon Proficiencies: Club, two-handed sword, hurling rocks

Nonweapon Proficiencies: Carpentry (19), rope use (12)

Appearance: Thurgh, now 13 years old, stands 11' tall, weighs 530 pounds, and has sandy brown hair that he wears in a braid that extends to the middle of his back. The young, muscular giant is still growing, and therefore usually goes barefoot so he does not have to continually buy custom-made shoes. He dresses in human garb – usually tent canvas pants and colorful broadcloth shirts that he orders specially tailored to fit his frame. Castron makes some of Thurgh's clothes.

Background: Thurgh spent his earliest years in the forests east of Neverwinter. The son of the hill giant clan chief Talco, he was pampered and looked up to by the other children. He looked forward to one day taking his father's place as clan leader, but he saw those plans dashed when a mercenary group called Satryn's Circle slaughtered the giants. Only the intervention of Joshua Kestrel saved young Thurgh.

Thurgh is exceedingly devoted to his adoptive father, and he tries hard to emulate Joshua by practicing languages and combat techniques and by trying to protect children.

Most people around the circus forget Thurgh is a child – especially when he works to help set up the Big Top and doubles as the circus's tall man. Some of the Mooney & Sons employees know Thurgh's race, but most consider him a human who suffered a strange curse that caused him to grow. Thurgh and Joshua do nothing to convince those people about the hill giant's true nature. However, Joshua and Thurgh know the truth eventually will come out when he keeps

growing. When Thurgh reaches maturity, he likely will stand 16' tall.

Thurgh is a reserve member of the Sandmen and shares a large wagon with Joshua and Castron the storyteller. He enjoys the company of Castron because he likes to listen to stories. He also likes to frequent the wagon workshop of G'Ned Klax, much to the unhappiness of G'Ned.

Castron Salizar

6th Level Male Half Elf Illusionist

STR: 12

INT: 17

WIS: 16

DEX: 17

CON: 12

CHA: 16

AC Normal: 4

AC Rear: 7

Hit Points: 20

Alignment: Chaotic Good

Languages: Common, Elvish, Thorass, Hill Giant, Halfling, Gnomish

Weapon Proficiencies: Staff, dagger

Nonweapon Proficiencies: Herbalism (15), artistic ability (storytelling) (16), carpentry (12), spellcraft (15), tailor (16)

Magic Item: *Ring of protection +3, flying carpet*

Spells/day: 4 2 2 plus one illusion per spell level

Spell Books

Level 1 Spells

*Audible Glamer**

Change Self

Spook

*Cantrip**

*Phantasmal Force**

Ventriloquism

Level 2 Spells

Blindness

Fool's Gold

Glitterdust

Blur

Hypnotic Pattern

*Improved Phantasmal Force**

Level 3 Spells

Illusionary Script

*Spectral Force**

Phantom Steed

Wraithform

* indicates spells Castron usually memorizes to help with his performance.

Appearance: Castron Salizar is 82 years old, stands 5'4" tall, and weighs 148 pounds. The white-haired, gray-eyed illu-

sionist sports a small potbelly beneath his robes. He usually dresses in dark purples, blues, and greens.

Background: Castron, who refuses to mention his birthplace or parents, has been with the Mooney & Sons Circus since its inception. In fact, the illusionist was in the very tavern where Jack Mooney gambled and won the circus.

Prior to the circus life, Castron studied with the wizard Dhergard near Candlekeep. He adventured for a short time until a number of close calls persuaded him to give up such a dangerous profession. Seeking new employment opportunities, he offered his services to the Silver Cord Theatre Troupe based in Suzail near Taneth's Feasthall. T'Beezly, the leader of the troupe, took the young magicker under his wing and instructed him in costume making and set construction. Castron stayed with the theater for several years, working on what he considered menial aspects of production and providing special effects. The troupe was coincidentally playing in Zazesspur, where the Full Moon Traveling Circus was winding up its performance. Castron saw Jack win the circus, immediately decided he liked the human, and asked to sign up. Jack, still suffering from the shock of his winnings, took him on.

Castron loves the cheers of the crowd and the smell of greasepaint. His affection for the circus shows in his two daily performances in the Big Top. He is billed as "Castron The Storyteller," entering the Big Top amid a trumpet fanfare and wild applause. He begins his show by floating to the center of the ring on his *flying carpet*. His tales center on grand journeys – usually escapades related to him by adventurers visiting the circus. He uses intense words, grand gestures, and illusions that illustrate the heroes and monsters in his tales.

When the Jack Mooney & Sons Circus is wintering in Ravens Bluff Castron is frequently hired by local nobles to entertain at special functions and birthday parties.

Despite all his years with the circus, Castron retains the wide-eyed, child-like wonder that first drew him to Jack's side. He is thrilled to help with any part of the circus's operation: rides, signposting, and sitting in for vendors who need a break. He also enjoys working with the Sandmen. He shares a wagon with Joshua Kestrel and the hill giant youth, Thurgh, who Castron hopes he can one day train as an apprentice illusionist.

The Big Top

Isbeau Navarne, The Animal Trainer

0 Level Male Human

STR: 12

INT: 17

WIS: 15

DEX: 16

CON: 18

CHA: 16

AC Normal: 8

AC Rear: 10

Hit Points: 8

Alignment: Neutral Good

Languages: Common

Weapon Proficiencies: Whip

Nonweapon Proficiencies: Animal handling (14), Animal training (great cats, monkeys, horses, and falcons) (15), animal lore (17)

Companion falcon (Imperius): Int Animal; AL Neutral; AC 6; MV Fl 36 (B); HD 1-1; hp 6; #AT 3; D 1/1/1; Size S (2')

Companion monkey (Cheem): Int Animal; AL Neutral; AC 8; MV 9; HD 1 + 1; hp 7; #AT 1; D 1; Size S (2')

Appearance: Isbeau Navarne is a burly man who stands nearly 6' tall. He is 45 years old and has black hair streaked with gray. His jade green eyes sparkle above a hawk-like nose. He carries himself proudly, giving off an air of self-confidence. He dresses in greens and browns when not performing. His Big Top outfits are usually multi-colored tights.

A native of Daggerdale, Isbeau grew up around animals, as his father, Harl, was a taxidermist who hunted almost daily. His mother died when he was very young. Isbeau's father tried hard to get the youth interested in his profession. Isbeau was interested enough in animals; he just had no desire to kill and stuff them.

Isbeau secretly resented his father and would sneak away from home to surround himself with living animals and nature. Animals seemed to like Isbeau, approaching him with little fear. He would spend hours watching birds building nests, beavers constructing dams, and deer grazing.

Isbeau's father considered the youth lazy because of his unexplained disappearances and because he seemed unable to force Isbeau to learn taxidermy skills. However, Harl could force Isbeau into hunting expeditions, even though the boy would not raise a hand against an animal. On one such forced trip, Harl was taking aim with his bow on the largest, most beautiful falcon he had ever seen. He was certain the bird would bring a good price when it was properly stuffed and mounted. Isbeau, who was 14, could not handle the situation any longer, and he shouted a warning to the falcon. The falcon flew, being missed by inches by an arrow from the furious Harl.

It was that incident in the woods that changed Isbeau's life forever. The youth didn't hear his father yelling at him. He heard the voice of the falcon inside his head, thanking him for the warning. The falcon was in reality Silvanus, who had chosen this day and location to visit the woods near Daggerdale. The god, who was in no danger from Harl's arrow, was nonetheless pleased with Isbeau's actions. Silvanus bestowed on the youth the ability to speak with falcons.

Isbeau considered the incident a magical experience, and did not realize a deity had granted him a special ability. He remained with his father for a few more years before striking out on his own. He traveled for a while, eventually meeting an animal trainer who accepted him as a student. Isbeau proved an excellent pupil, quickly learning the trade and discovering his ability to talk to falcons.

Isbeau worked the next decade training horses for the nobility of various communities along the Sword Coast. One of his clients made a passing comment about using his skills at the circus that was playing in town, and Isbeau took the message to heart.

He approached Jack Mooney's sons, as the ringmaster was occupied. Mooney's sons, recognizing Isbeau as a rare find, signed him on and bragged about the addition to their father. Isbeau fits in well with the circus, where all the animals are treated well. He gets along exceptionally with Jack Mooney, who shares his views on animals.

Isbeau's Big Top act includes great cats and a small monkey. He coaxes the cats to jump through hoops on fire, balance on pedestals, leap over bars, and parade about the center ring. A staple to the performance is the monkey, Cheem, who rides on the lead cat's back, chittering and

pretending to bother the animal. At one point, the monkey grabs the cat's tail and hangs on, flying wildly in the air. Many children have become great fans of Cheem and throw him fruit and nuts after the performance.

During the day, Isbeau trains horses and animals for other acts and works with his own falcon, Imperius, which he acquired while the circus traveled on its circuit to Waterdeep. Imperius, which is not included in his act, can retrieve, search, scout, and attack on command. He shares a special rapport with the bird because he can talk to it. Cheem, who attempts to imitate the falcon, has learned how to retrieve.

When the circus winters in Ravens Bluff, Isbeau searches for adventuring parties and attempts to sign on as a temporary member. He wants the adventurers to help him capture great cats and other animals that can be used in the circus. If an adventuring group will not accept his presence, he tries to commission the group to capture animals. In any case, Isbeau emphasizes the animals are not to be harmed.



The Big Top

Doagar The Beholder Tamer

This recent addition to the Big Top line-up thrills audiences with its spectacular effects and dangers. The act is bright, flashy, and completely fake. It was concocted largely by the three remaining members of a failed adventuring company: Doagar the fighter, Thanthal the mage, and Remdar the illusionist.

Before the act begins, Thanthal *polymorphs* herself into a beholder and casts a *fly* spell so she can move like the dread creature. After receiving some makeup, mostly packets of artificial stage blood and enough grease paint to cover them, she casts non-detection on herself and enters a large iron-bound wooden chest. As the show begins, the announcer, usually an older roustabout dressed in gaudy clothes, introduces "Doagar the Magnificent, one of the few men in the Realms brave enough to face such incredible danger!" The warrior enters to applause and bows to the assembled crowd. Following closely are two burly men carrying the large chest holding Thanthal. Doagar is equipped with a shiny, collapsible long sword and a magnificent shield with a round, gaping hole and a breakaway plug.

Continuing after the applause slows, the announcer states, "Inside the chest is one of the most terrifying creatures known to mankind! The beholder! Its incredible magical powers are made even more dangerous by its insatiable greed and cunning intelligence! A spell cast on the box keeps the monster helpless until it is released. For your continued well-being when it is released, however, we must provide some protection. Ladies and gentlemen, the wizard Remdar the Wondrous, who will create a magical shield for your safety." Remdar enters the ring, bowing. With exaggerated gestures and incantations, he casts an *illusionary wall* around the ring, so that only Doagar and the chest remain inside. Meanwhile, the announcer continues: "Many of you know that the beholder possesses a powerful anti-magic ray which emanates from its central eye, but rest assured that the eye has been disabled and cannot be opened. Some of the still-dangerous powers that Doagar the Magnificent must avoid include the gray ray which would turn him to stone; the red which would seriously wound him; and the dreaded purple ray which could

disintegrate him or his possessions. Finally, he must at all times avoid the black death ray produced by the monster." After pausing to allow the crowd to absorb the information (which some adventurers may recognize as false), he says, "Let the spectacle begin!"

Doagar quickly opens the chest and backs up. Thanthal slowly rises out of the box and turns completely around so the entire crowd can view her. Doagar runs toward her and thrusts with his sword, but is quickly driven back by a barrage of flashing lights originating from the creature's eyestalks (a *flash* spell cast by Thanthal). Some flashes hit Doagar's shield and bounce off, while others shoot toward the crowd only to splash harmlessly on the "protective" shield. After a pause and some maneuvering, the beholder releases a pulse of purple which hits the warrior's shield, creating a gaping hole in it. (Doagar knocks out the plug). Then a red ray strikes Doagar and he falls to the ground, face down. The announcer emphasizes the danger of his situation. Doagar rises quickly, with bloodstains dotting his tunic (caused by dye-filled paper packets broken when he fell). Doagar begins a whirlwind attack, leaping in to hack at the eyestalks. Remdar casts a *spectral force* showing three severed eyestalks tumbling to the ground. Thanthal looses a terrible scream and whirls about, which keeps viewers from counting the eyestalks and realizing that none really are missing. The beholder again turns toward Doagar and (casting another *flash* spell) releases another barrage of eye beams. Avoiding the rays is strenuous for the warrior, and after running about the ring, he dives away from one last pulse and lands gasping on the ground. The beholder then turns toward the audience, and its central eye begins to open. Turning toward Remdar the Wondrous, it emits a pale blue ray from the central eye, and the protective shield goes down (*dispeled* by Remdar). The announcer tells the audience to not panic. Before shock can turn to panic, the beholder rushes to a stunned Remdar, bites at the frantically gesturing wizard, and shoots him with a purple ray, causing him to disappear (Remdar casts *invisibility* and quietly leaves the ring). Doagar rises, stumbles to the monster, and thrusts with his collapsible sword; which appears to plunge deeply into the beholder's body, "killing" it. The beholder drops to the ground, lying where it falls like a deflating ball. The act is over, and the actors clear the set while the announcer calms

the crowd and demands applause for the brave warrior.

New Wizard Spell

Flash (*Alteration*)

Level: 2

Range: 0

Components: V, S

Duration: Special

Casting Time: 1

Area of Effect: Special

Saving Throw: Special

This basically harmless spell causes an impressive light show. The spell generates two light beams for each level of experience the caster has. These can be released from the fingertips as rapidly as three per round, or as slowly as one per round. The beams can be of any color; they are 30 yards long and are stopped by physical objects, visual illusions, and any upper level force spell, such as *minor globe of invulnerability*, *wall of force* and similar spells.

The rays can dazzle creatures if they are struck directly in the eyes. A creature struck by a ray is dazzled unless the caster deliberately avoids the eyes, or unless the creature saves vs. paralyzation. Dazzled creatures receive a penalty of -1 to attack rolls made during the next round. The dazzling effect is not cumulative for multiple hits in the same round, but can be repeated by subsequent hits. Blind or eyeless creatures cannot be dazzled.

Doagar

4th Level Male Human Fighter

STR: 17

INT: 6

WIS: 13

DEX: 12

CON: 16

CHA: 16

AC Normal: 4

AC Rear: 5

Hit Points: 27

Alignment: Chaotic Good

Languages: Common, Orcish

Weapon Proficiencies: Long sword, dagger, spear, sling, whip

Nonweapon Proficiencies: Artistic ability (acting) (13), rope use (12), blind-fighting, endurance (16)

Magic Items: Long sword +1

Appearance: Doagar stands 5'11" and weighs 170 pounds. He is muscular and

The Big Top

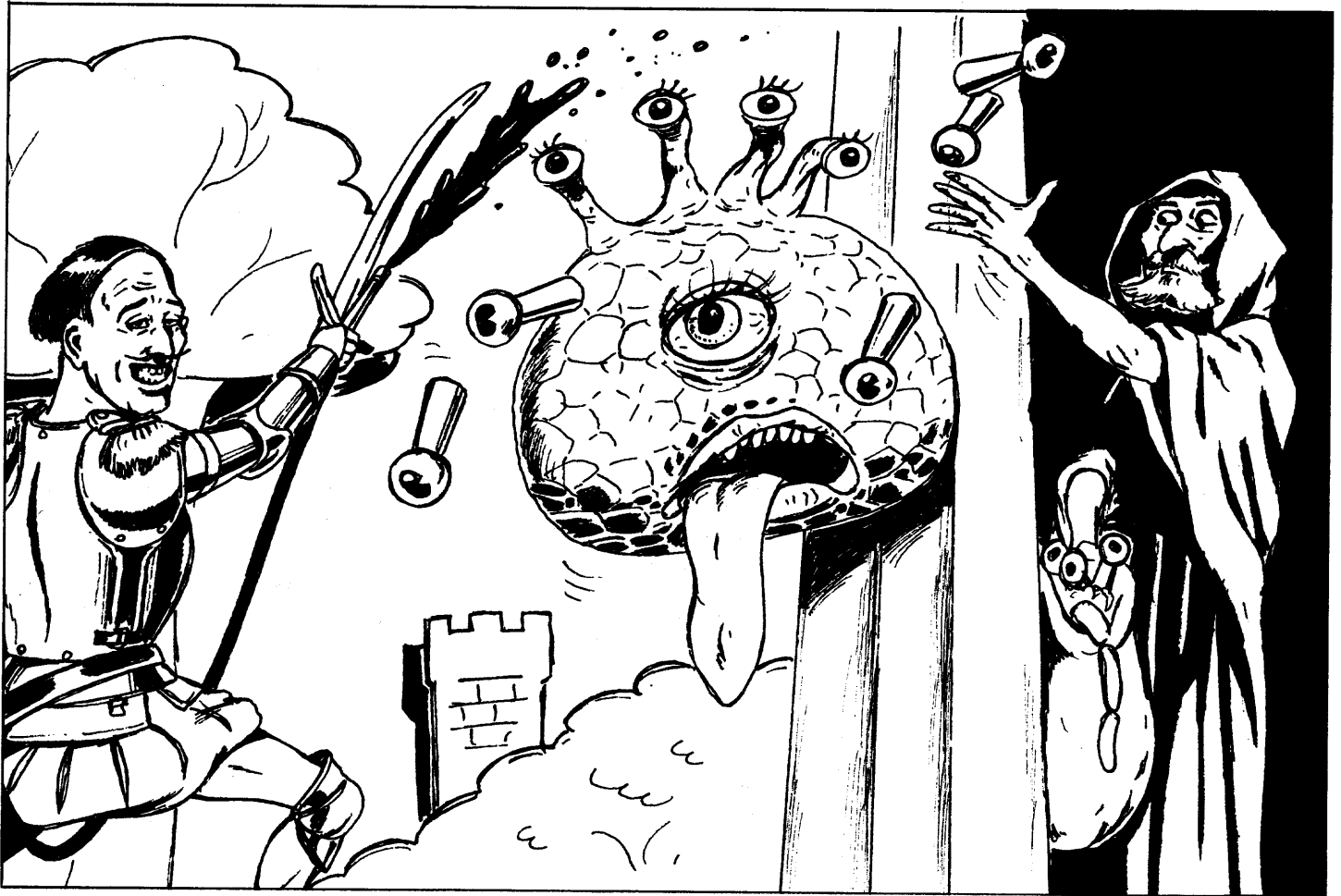

has blond hair which falls loose to his shoulders. The 24-year-old Doagar pays much attention to his appearance in the ring and is always looking for new, flashy clothes.

Background: Once a prosperous adventurer, Doagar met with disaster in the form of a wizard and his legions of undead. He lost three levels and six points of intelligence in the ensuing campaign, and he decided to retire from active adventuring. He now considers himself too stupid for a life of real danger. When he and his surviving companions discovered the circus, Doagar came up with the idea of putting together an act. He is happy with the circus people, considering them his family. He has several ideas about adding to the act, such as using a whip or spear, or wearing a blindfold. He fears ridicule, however, and mentions the ideas only after he has had too much to drink.

Thanthal

7th Level Female Human Mage

STR: 9
INT: 16
WIS: 12
DEX: 6
CON: 7
CHA: 11

AC Normal: 10

AC Rear: 10

Hit Points: 20

Alignment: Neutral

Languages: Common, Elvish, Centaur, Halfling, Lizardman

Weapon Proficiencies: Dagger, sling

Nonweapon Proficiencies: Direction sense (13), reading/writing (17), spellcraft (14), astrology (16) fishing (11)

Spells/day: 4 3 2 1

Magic Items: *Potion of healing, oil of slipperiness*

Spell Books

Level 1 Spells

*Unseen Servant**
Sleep
Read Magic

*Cantrip**
Magic Missile
Detect Magic

Level 2 Spells

*Flash**
Levitate
Web

Invisibility
Strength
Wizard Lock

Level 3 Spells

Spectral Force
*Non-Detection**

Fly
*Dispel Magic**

Level 4 Spells

*Polymorph Self**

Confusion

* Spell usually memorized daily for use in the act.

The Big Top

Appearance: When not in her beholder disguise, Thanthal appears as a sickly woman, 5'4" tall and weighing 102 pounds. Her hair is black and worn short. Thanthal favors robes for normal dress. She is 27 years old.

Background: Like Doagar, Thanthal was severely injured in the campaign against the wizard and his undead. She contracted a virulent disease which led to her present state of physical disability. Her husband, who was the party cleric, was slain. After Doagar suggested they join the circus, Thanthal designed the act. She sometimes feels bitter toward the other cast members. In her opinion, she invented the act and now they steal all the glory and adoration that should be hers. Thanthal is not entirely satisfied with using *non-detection* spells to cover her own spell use during the act, and would very much like to obtain an *amulet of proof against detection and location*. She would be very interested in any proposal that would give her one or even give her a good chance of getting one.

Remdar

7th Level Male Human Illusionist

STR: 8
INT: 17
WIS: 9
DEX: 16
CON: 7
CHA: 14

AC Normal: 8

AC Rear: 10

Hit Points: 19

Alignment: Neutral Good

Languages: Common, Elvish, Halfling, Dwarvish

Weapon Proficiencies: Dagger, staff

Nonweapon Proficiencies: Reading/writing (18), spellcraft (15), singing (14), rope use (16), swimming (8), ancient history (16)

Spells/day: 4 3 2 1 plus one illusion per spell level

Magic Items: *ring of spell storing* (contains *dispel magic* and *unseen servant*)

Spell Books

Level 1 Spells

| | |
|--------------------------|---------------------|
| <i>Phantasmal Force*</i> | <i>Cantrip*</i> |
| <i>Color Spray</i> | <i>Knock</i> |
| <i>Read Magic</i> | <i>Detect Magic</i> |

Level 2 Spells

| | |
|-----------------------------------|----------------------|
| <i>Flash</i> | <i>Invisibility*</i> |
| <i>Improved Phantasmal Force*</i> | <i>Misdirection*</i> |
| <i>Mirror Image</i> | <i>Blindness</i> |

Level 3 Spells

| | |
|--------------------------------|-------------|
| <i>Spectral Force*</i> | <i>Fly</i> |
| <i>Invisibility 10' Radius</i> | <i>Item</i> |

Level 4 Spells

| | |
|--------------------------|-----------------------|
| <i>Illusionary Wall*</i> | <i>Minor Creation</i> |
|--------------------------|-----------------------|

* Spell usually memorized daily for use in the act.

Appearance: The 24-year-old Remdar looks quite distinguished, with his jet-black hair, mustache, and fine clothing – he always takes pains to dress well. For the act, Remdar sports a fine gray robe with a voluminous hood and sleeves. He is 5'9" tall and weighs 150 pounds.

Background: Like the other members of his group, Remdar suffered injury at the hands of wizards and undead. He never liked adventuring and was quite happy to retire to the circus, where his already huge ego is periodically inflated even more. He refuses to change the act unless the change makes him look better. Remdar relies on Thanthal to keep his *ring of spell storing* charged.

Bjorn The Bear Wrestler

Bjorn The Bear Wrestler usually can be found in a large red and yellow striped tent in the midway. His act is a sideshow attraction that regularly draws a crowd, but occasionally it moves to the Big Top if the circus is short of talent.

Bear wrestling is not a simple task, although Bjorn makes it look easy. Midway patrons pay one copper piece to view the show, which is put on inside the tent.

When the act begins, Bjorn's assistant Ben brings out Kingston, a large brown bear. Kingston snarls and growls appropriately and parades back and forth in front of the audience. Then the bear is taken behind a curtain and Bjorn takes the stage. He tells the audience about bears – how powerful, large, and dangerous they are. And he instructs them

never to try what he is about to demonstrate.

His assistant brings out the bear for Bjorn to wrestle. However, it is not the same bear. This is Sylvester, a trained bear which has no teeth or claws. Bjorn wrestles with Sylvester and makes it look like the bear is winning. Eventually Bjorn pins the bear, and the crowd usually goes wild.

On rare occasions when Bjorn knows there is an adventurer or two in the audience, he asks if one of them would like to try bear wrestling. Any takers are faced with wrestling Kingston according to the unarmed combat tables in the *Dungeon Master's Guide*. Bjorn calls the competition after seven rounds or if it looks like Kingston or the wrestler is getting seriously hurt. Kingston fights as if to subdue the wrestler. This challenge never is offered under the Big Top.

Bjorn The Bear Wrestler

4th Level Male Human Fighter

STR: 18/90

INT: 12

WIS: 11

DEX: 15

CON: 16

CHR: 14

COM: 11

AC Normal: 9

AC Rear: 10

Hit Points: 34

Alignment: Neutral Good

Languages: Common, Elvish

Weapon Proficiencies: Long bow, long sword, dagger, whip, lasso

Nonweapon Proficiencies: Animal lore (12), endurance (16), gaming (14)

Magic Items: *Long sword +1, long bow +2*

Appearance: Bjorn is 35 years old, stands 6'5" tall, and weighs 185 pounds. He has light blond hair, a short beard which looks almost white, and ice blue eyes.

Background: About 15 years ago Bjorn was an adventurer, traveling with cousins in the lands far north of Ravens Bluff. However, the life didn't suit him, as he often had moral qualms about killing creatures for treasure. He found more pleasure in watching creatures, especially bears, and eventually opted to live in the wilds so he could observe them more closely. Bjorn would have been a druid if he could have found the right tutor.

The Big Top

Six years ago Bjorn was studying a brown bear cub which had wandered close to his camp. He was so preoccupied watching the cub that he didn't notice the cub's mother coming up behind him. Bjorn had to fight the bear, and nearly lost his life before he was able to break its neck. He was injured in the struggle, his leg badly mangled. Although he recovered from the incident and can walk straight, his maximum movement is 9.

Bjorn adopted the orphaned cub, named it Kingston, and returned to civilization. He traveled from village to village, charging children a copper to view his tame bear. The bear grew, and his tactics altered to wrestling the bear in public – for a fee, of course. Bjorn always won, as he taught the bear to let him pin it. Eventually, however, village elders believed the bear too dangerous to allow it within their gates. Bjorn returned to the wilderness, crossing paths with the Mooney And Sons Circus, which was between cities. Bjorn fell in with the troupe, and devised the bear wrestling act.

Bjorn found wrestling Kingston to be a little too difficult, even though the bear was his friend and never tried to hurt him. Kingston's mere size and his sharp claws and teeth were a threat Bjorn didn't want to deal with. About six months after joining Mooney, Bjorn purchased a bear a little smaller than Kingston. This bear had no teeth or claws, and Bjorn felt more comfortable wrestling it. Jack Mooney's daughter, Silva, helped him train the bear, which he called Sylvester in her honor, and he has been using it in his act ever since.

Bjorn retained much of the treasure he accumulated during his adventuring days – 8,000 gold pieces which he stores in a secret compartment in Kingston's cage. He also keeps his *long sword* +1 and his *long bow* +2 there.

Bjorn is assisted by Ben Hakerty, a friend from his adventuring career.

Ben Hakerty

O Level Male Human

STR: 16
INT: 8
WIS: 10
DEX: 15
CON: 14
CHR: 9
COM: 8
AC Normal: 9
AC Rear: 10
Hit Points: 3
Alignment: Neutral Good
Languages: Common

Weapon Proficiencies: Knife

Nonweapon Proficiencies: Animal handling (12)

Magic Items: none

Appearance: Ben is 37 years old, weighs 150 pounds, and stands 5'8" tall. He has shoulder-length walnut brown hair, a brown bushy beard streaked with gray, and hazel eyes.

Background: Ben worked as an animal handler for his father's ranch near Waterdeep. He met Bjorn when the ranch workers were driving a herd to a nearby market. The herd was attacked by goblins, and Bjorn and his cousins slew the creatures and saved the herd. Ben and Bjorn became friends, and the two frequently crossed paths. Ben left the ranch business and unsuccessfully tried his hand at adventuring. When he saw Bjorn at a Mooney And Sons performance, he joined up with the act.

Ben enjoys circus life and being with his friend, Bjorn. He has also taken a fondness to Kingston, whom he grooms every day.

Kingston

Intelligence: Semi; **Alignment:** Neutral; **AC:** 6; **Movement:** 12; **Hit Dice:** 5+5; hp 44; **THAC0** 15; **No. Of Attacks:** 3; **Damage:** 1-6/1-6/1-8; **Special Attack:** hug; **Size:** L (9' tall)

Sylvester

Intelligence: Semi; **Alignment:** Neutral; **AC:** 6; **Movement:** 12; **Hit Dice:** 5 + 5; hp 28; **THAC0**



The Big Top

The Talking And Singing Owlbear

Orgbarh, the famed "Talking And Singing Owlbear," is one of the most popular acts at the Jack Mooney & Sons Circus, especially with the children. The flamboyant owlbear gives a brief performance once a day in the midway and is a regular under the Big Top. In addition, when the Mooney & Sons Circus winters in Ravens Bluff, the owlbear entertains at birthday parties for the children of noble and wealthy residents. Of course, Orgbarh charges hefty fees for these engagements.

Despite appearances, the talented owlbear is not all that he seems. In fact, he is a once-charmed owlbear who is able to entertain only because Cinna Maclyre, a high-level bard, stands backstage and uses ventriloquism to make it seem like Orgbarh is singing.

The performance begins with a dark stage. Orgbarh moves out onto it accompanied by the cheers of the spectators. Cinna illuminates the area with a *light* spell, and the act begins. Orgbarh struts back and forth across the stage, swaying rhythmically and moving his mouth while Cinna talks and sings using his natural ventriloquism ability. Cinna hides backstage or in the shadows throughout the performance. If the audience is extremely receptive, Orgbarh and Cinna keep up the act for about a half hour, finishing with a joke or two. If the crowd does not find the joke amusing, Cinna casts *Tasha's uncontrollable hideous laughter* to get a desired response.

The show concludes with Orgbarh bowing a few times and Cinna casting *darkness*, *15' radius* to cover the owlbear's exit.

During the performance, Bithlain, Cinna's associate, moves through the crowd picking a few pockets. The thief is careful not to pick more than a dozen pockets a night; more activity could draw the attention of Jack Mooney and the city's law enforcement officials. The thief does not have such a self-imposed limit when he travels through town.

Very few circus performers know the true nature of Cinna and Orgbarh's act; most actually believe the owlbear is magical or unique and that Cinna is his trainer.

Cinna Maclyre

12th Level Male Human Bard

STR: 13
INT: 18
WIS: 7
DEX: 14
CON: 10
CHR: 17
COM: 13
AC Normal: 6
AC Rear: 6
Hit Points: 51
Alignment: Neutral
Languages: Common, Elvish, Halfling

Weapon Proficiencies: Dagger, hand axe, long sword, sling

Nonweapon Proficiencies: Gem cutting (13), musician (lute) (15), reading lips (16), ventriloquism (18)

Magic Items: *Leather armor +2, long sword +2, ring of invisibility, bag of tricks* (type C), *wand of magic detection* (47 charges)

Spells/Day: 3 3 3 2

Bard Skills

CW DN PP RL

90 45 70 65

Identify Item: 60%

Spell Books

Level 1 Spells

| | |
|----------------------|----------------------|
| <i>Charm Person*</i> | <i>Detect Magic*</i> |
| <i>Feather Fall</i> | <i>Light*</i> |
| <i>Magic Missile</i> | <i>Taunt</i> |

Level 2 Spells

| | |
|------------------------------|---|
| <i>Darkness, 15' Radius*</i> | <i>ESP*</i> |
| <i>Forget</i> | <i>Tasha's Uncontrollable Hideous Laughter*</i> |

Level 3 Spells

| | |
|----------------------------------|----------------|
| <i>Invisibility, 10' Radius*</i> | <i>Slow*</i> |
| <i>Suggestion*</i> | <i>Tongues</i> |

Level 4 Spells

| | |
|-------------------------------|-------------------------|
| <i>Charm Monster</i> | <i>Fear</i> |
| <i>Improved Invisibility*</i> | <i>Rainbow Pattern*</i> |

*Spells usually memorized

Appearance: Cinna is 35 years old, stands 5'7" tall and weighs 149 pounds. He has short curly brown hair and sky blue eyes. He usually wears a black tunic with his leather armor concealed underneath it. His cloak, boots, and broad-brimmed hat are also black. He usually carries his *long sword* and his *bag of tricks* wherever he goes. In addition, he wears hidden daggers — one on his back and another attached to his left forearm. He typically carries 50 gp, 10 pp, and an assortment of gems valued between 2,000 and 3,000 gp. He stores the remainder of his wealth with Orgbarh for safe keeping.

Background: Cinna was born in Aglarond to weavers who rented shop space in the merchants quarters. Weaving did not appeal to him, so at an early age he left home and began studies as a bard.

He traveled for many years with a small adventuring party; and on one expedition four years ago the group uncovered a large treasure haul. At the time, Cinna's lust for wealth and magic were strong, and he tricked the party out of most of the wealth and all of the magic items. He fled to avoid their wrath — straight into the path of a hungry owlbear. Cinna cast *charm monster* on the creature and took it with him to Ravens Bluff. Monsters are not allowed in the city, so the only way Cinna could get Orgbarh inside was to claim he was auditioning for Jack Mooney & Sons Circus, which was wintering in the city at the time. Cinna tried out and was immediately hired. The circus life appealed to him because he could travel throughout the Realms, thereby likely avoiding his former adventuring companions. In addition, Cinna enjoyed the pay and the companionship of the other circus employees. He has no desire to return to the life of an adventurer.

During his first few years with Orgbarh, he regularly cast *charm monster* to keep the creature in line. However, the owlbear has become domesticated and quite attached to Cinna. He no longer needs magic to control Orgbarh.

Cinna is outgoing and charismatic. He enjoys to talk to adventurers and hear tales of their past exploits. He is a very good source of information for adventurers; however, he does not like to be considered a gossipmonger. He will sometimes pass on clues of ruins or treasure in exchange for a fee. Occasionally he hires groups of adventurers to obtain spell components for him and exotic treats for Orgbarh.

The Big Top

Bithlain Lightfoot

13th Level Male Halfling Thief

STR: 8

INT: 17

WIS: 6

DEX: 18

CON: 12

CHR: 13

COM: 12

AC Normal: 3

AC Rear: 7

Hit Points: 47

Alignment: Neutral

Languages: Common, Elvish, Halfling

Weapon Proficiencies: Dagger, hand crossbow, knife, short sword, sling

Nonweapon Proficiencies: Appraising (19), disguise (12), horse riding (9), rope use (18), set snares (17), swimming (8), tightrope walking (18)

Magic Items: *Leather armor +1*

Thief Skills:

PP OL FT MS HS DN CW RL

95 85 55 95 95 40 80 10

Backstab for quintuple damage.

Appearance: At 3'1" tall, Bithlain is an average-sized halfling. His weight of 90 pounds is due to his well-rounded stomach that he gained by drinking and eating too much. Despite his appearance, Bithlain is agile and has excellent hand-eye coordination. He demonstrates it occasionally by juggling apples and other food items as he walks through the midway.

He usually wears dark green silk breeches, a brown tunic, blue boots, and a deep blue broad-brimmed hat. He leaves the hat behind when he goes on pickpocketing missions. He is never without his magical daggers — one of which he conceals in his boot, the other in a sheath at his belt.

Background: Bithlain comes from the southern halfling kingdom of Luiren. His father was a merchant, and Bithlain traveled with him often around the Shaar and even as far north as Turmish. However, Bithlain was bored with the life, wanting more wealth than an honest merchant's work could bring. He left home while he was still very young and sought his fortune by signing on as a caravan guard. Later he joined a band of adventurers and stayed with them for several years

until the risks became too great and the monsters too fearsome. He decided to retire in Ravens Bluff.

Jack Mooney & Sons Circus was visiting the city when Bithlain opted to take in a performance a year ago. Unfortunately, he tried to take a few things from a lone human standing outside the main tent. The human, Cinna, caught the little thief and opted not to turn him in. The pair became fast friends, and Cinna offered him a job helping with Orgbarh's act. Bithlain, ever looking for new opportunities, agreed.

Bithlain is optimistic, tactful, and tries not to insult people; he believes he has enough enemies as it is. He enjoys collecting gems, especially pearls. In his off-duty hours he can be found visiting local jewelry shops looking through their pearls, and often paying the shops more than the pearls are worth. Bithlain is wise enough not to jeopardize himself by stealing from merchants, whom he has a soft spot in his heart for. He remembers back to the time his father struggled with his merchant business.

Bithlain is cheerful to all the other circus employees, who in turn like the plump halfling and often invite him to their tents for meals. He also is fond of Orgbarh, who guards his gem collection.

Orgbarh

Male Owlbear Entertainer

Intelligence: Average (9)

Alignment: Neutral (Good tendencies)

Armor Class: 5

Movement: 12

Hit Dice: 5+2

Hit Points: 29

THAC0: 15

No. of Attacks: 3

Damage/Attack: 1-6/1-6/2-12

Special Attacks: Hug

Special Defenses: Nil

Magic Resistance: Nil

Size: L (8' tall)

Appearance: Orgbarh is a male owlbear, about 20 years old, who stands 8' tall and weighs 1,426 pounds. He has dark brown feathers and an ivory beak. His eyes are black with crimson rings around them.

Background: Orgbarh was originally owned by a mad wizard who *charmed* him and ordered him to exact revenge on everyone who had annoyed the wizard; to the wizard this was anyone on his prop-

erty. Orgbarh wandered for months killing people who came upon the wizard's property. Cinna was one such trespasser. However, Cinna *charmed* Orgbarh, overriding the *charm* of the mad wizard.

Through the past few years, Orgbarh has become domesticated, has taken a liking to humans — especially those who cheer and applaud for him, and has become very protective of Cinna. He is also fond of the halfling, Bithlain, and of Jack Mooney, who almost daily brings him treats.

Orgbarh is accepted by nearly all of the circus employees, who take his appearance in the midway and around the circus grounds for granted. Orgbarh is allowed to wander freely — within the circus boundaries — when the circus is closed. Jack Mooney considers him a "watch dog," knowing that Orgbarh would attack anyone or anything that attempted to harm the circus employees.

The Big Top

Big Top Clowns

Frizzo (aka Franklyn Reginald Zolt)

5th Level Male Human Thief

STR: 16
INT: 12
WIS: 10
DEX: 18
CON: 12
CHA: 15
AC Normal: 6
AC Rear: 10
Hit Points: 20
Alignment: Chaotic Neutral
Languages: Common

Weapon Proficiencies: Dagger, sling, short sword

Nonweapon Proficiencies: Read lips (11), ventriloquism (10), tumbling (18)

Magic Item: *Ring of invisibility*

Thief Skills

PP OL FT MS HS DN CW RL
85 65 10 50 65 15 60 --

Appearance: Frizzo is 34 years old. He weighs 165 pounds, stands 5'9" tall, and has brown eyes and short curly black hair. When dressed as a clown, he wears a green, purple, and yellow cloak with a matching floppy hat, a red tunic, orange soft leather boots, and striped orange and purple hose. He always carries a concealed leather pouch containing six matched bloodstones, and another that contains 11 silver and 13 copper coins.

When not in costume, he still goes by the name Frizzo and wears a soft brown robe with a connected hood. In this guise, he carries two jeweled daggers — each one concealed in a boot. When in this persona, he monitors other clowns and eavesdrops on circus patrons to learn what they liked and disliked about his performance.

Background: The head clown for the Mooney & Sons Circus is the son of two failed mages — Davidson Zolt and Zelda Spellmonger. Although poor and unskilled at their chosen profession, Zelda and Davidson had great hopes that Franklyn would grow up to be a great mage, and they gave him a name to match his anticipated greatness. When he was four, his parents were killed in the back-

lash of a faulty magical experiment. This forced him and his two brothers into the streets of Ravens Bluff.

They saw their only chance for survival in the Beggars Guild. Thus, Franklyn grew up in the slums learning to beg. He was never comfortable taking money for nothing, so he tried to “pay” for the money people gave him by entertaining them with a dance or a song. He soon learned he had little talent, but almost everyone thought his attempts were cute and humorous. So Franklyn continued to entertain, usually emphasizing his lack of skills to make his performance even more humorous. Using this approach, he soon earned more than his brothers, making him the family bread-winner.

For the next few years he continued to beg until he got older and the passersby no longer found his act cute. With few real options, and no desire to starve, Franklyn joined the city’s smallest thieves guild on his ninth birthday. His natural dexterity combined with his strong determination to get out of the slums made him a quick learner; he passed his apprenticeship in record time. His brothers, having no desire to follow in his footsteps, abandoned him and went their own ways.

By the age of 15, Franklyn was well established in the guild and had moved out of the slums. As he passed into his later teens, his great successes became a liability in the constant political battles for control of the guild. Although Franklyn wanted nothing more than to perfect his skills as a thief, he often found himself drawn into the squabbles. Eventually, he decided to look elsewhere for work.

Franklyn always had been fond of the circus and visited it often when it wintered in Ravens Bluff. It provided him a very good income, as the crowds were a perfect target for a good pick pocket. It came to him that the circus might be just what he needed.

Fortune again smiled on Franklyn, as the clown apprentice to The Great Marple was injured in a fall and would not be able to leave with the circus for its summer tour. The Great Marple advertised for a new replacement, and Franklyn was accepted for the job.

Although Franklyn had no real clown training, his agility and thieving abilities made him a natural. He also had some experience with disguise, though he never tried anything as ridiculous and concealing as a clown. Plus, his tumbling skills made it easy for him to learn the routines.

Five years ago The Great Marple decided to retire. The king clown had been delighting audiences for more than three decades when he decided to finally hang up his floppy shoes and wild wig. Franklyn/Frizzo moved into his position and recruited Splatter as his apprentice.

Frizzo’s goal is to surpass The Great Marple.

Frizzo still plies his second profession, although less often and more selectively than before. He uses his position at the circus to find his victims. He limits himself to burglary, not wanting to jeopardize his post with the circus by pick pocketing those in the crowds.

He is in charge of all the clowns in the circus, the most talented clowns are himself and his friend, Splatter.

Frizzo enjoys making people laugh and usually plays the “heavy” to Splatter. Unlike most clowns, Frizzo has not developed a trademark, preferring to change his act regularly — usually every two to three weeks.

He takes his job of entertaining the customers very seriously and is always looking for new ideas and material. As head clown he is expected to supervise the others. However, management is not something he takes seriously. He believes they do just fine without his constant intervention. Besides, Frizzo believes that managing the others would take away from his own time to entertain and to perfect his many routines.

Frizzo works very hard to keep his act fresh and entertaining. If he can maintain his current pace, he could very well surpass The Great Marple in the hearts of the people of Ravens Bluff. Because he appears to many as the consummate clown, no one is aware he has another profession.

In the 15 years he has lead his dual life as clown and thief he has never been caught.

The Big Top

Splatter (aka Lionel Silverspeak)

5th Level Male Human Bard

STR: 14
INT: 14
WIS: 12
DEX: 16
CON: 12
CHA: 15
AC Normal: 8
AC Rear: 10
Hit Points: 21
Alignment: Neutral Good
Languages: Common

Weapon Proficiencies: Dagger, lasso, dart

Nonweapon Proficiencies: Juggling (15), tightrope walking (16), rope use (16), tumbling (16)

Magic Item: *Ring of feather falling*

Spells/day: 3 1

Bard Skills

CW DN PP RL
75 40 30 20

Spell Book

Level 1 Spells

Comprehend Languages Erase
Protection From Evil Spider Climb

Level 2 Spells

Knock Mirror Image

Appearance: Splatter is 31 years old, weighs 172 pounds, and stands 5'8" tall. His eyes are a piercing emerald green, and his wavy brown hair hangs just below his ear lobes. He is rarely seen in anything other than a clown outfit. His current favorite outfit consists of a lime green and blood red cloak with a matching, three-balled fool's cap, an aqua tunic and hose, and a pair of indigo soft leather boots.

When working outside of the main tent, Splatter carries a small leather pouch concealed in his costume. He carries a few coins and magical components in it. At any given time he will have 11 silver and four copper coins, wrapped to keep them from jingling.

Background: Splatter was born Lionel Oster Silverspeak, son of Hans and Christina Silverspeak. Both of his parents

worked on the estate of Lord David Meer-cant Oster Blacktree IV. However, his mother died when she was giving birth to Lionel's sister. The infant died a few hours later, never having been named. Lionel was nearly three years old at the time.

Lady Melanie Blacktree, the lady of the estate, raised Lionel along with her two sons, David and Charles. Lionel became best friends with David, and the two played together, went to school together, and grew up like they were brothers.

David and Lionel usually excluded Charles – mostly because Charles was quite a bit younger. Charles never forgave Lionel for "stealing" his brother.

Because he had few playmates, Charles spent much of his time with his mother and became quite spoiled. By the time Lionel and David discovered they were being unfair to the younger boy, it was too late; Charles decided he didn't want their company.

Lionel enjoyed all the advantages of nobility through his association with David and the wealthy Blacktree family. However, all of this changed eight years ago when David, his father, and his mother were killed. Lord David had wanted to take his new ship, Dragon's Claw, on its first sea voyage before the crisp autumn winds turned wintry. The trip was to be a short jaunt around Lone Rock and back. Unfortunately, an early storm thundered through The Dragon Reach, driving the ship and its passengers and crew onto the rocks.

Charles survived because he opted to stay behind partying and carousing. With his relatives dead, Charles inherited the estate and his father's title of Lord Speaker of the Advisory Council (see Gateway To Ravens Bluff, LC1). Lionel found that the privileges he had enjoyed as David's best friend died with David, and he was kicked off the estate.

Lionel discovered that his education, which had focused on the arts and literature, provided him with few useful skills for the Ravens Bluff job market. To complicate matters, everywhere he looked for a job he found Lord Charles one step ahead of him, closing doors and opportunities. With no place to live, no friends, and no job prospects, Lionel was desperate. His sad state led him to the circus, which was packing up and preparing to leave for its annual circuit. He saw the circus as an opportunity to leave Ravens Bluff and the oppressive presence of Lord Charles. Swallowing what was left of

his pride, Lionel signed on for the season.

Frizzo took an immediate liking to the roustabout and encouraged him to become a clown. Lionel had been tumbling and practicing his musical skills during lunch breaks, and Frizzo thought the combination made the man a natural comedian.

Initially, Lionel rebelled at the idea, but he was tired of lugging tents around and assumed clowning would be a lot easier. He soon found out how wrong he was, but by that time he enjoyed his new-found profession and was hooked on the circus. He felt like he belonged; he had a family, friends, and a new life. He never refers to himself as Lionel anymore – he is only Splatter.

Splatter is especially fond of children and works hard to make them laugh. He is certain that Lord Charles does not know about his new identity.

Few in the circus remember what Splatter really looks like, as they never see him without his makeup and costume.

His clown image is that of a bumbling, clumsy comic; he is the epitome of slapstick.

Splatter appears for 20 minutes during each Big Top performance. Between shows he wanders the midway. His trademark is his "splatter" routine. He spent almost two years developing the routine, and he continues to enhance it. He uses *mirror image* and his tumbling skills to make it appear like he splatters himself against the side of the tent. This routine has made him one of the favorites in the circus, except in the eyes of passing adventurers who see through his routine and recognize the *mirror image* spell. In his other bits Splatter uses his tumbling, juggling, rope use, and tightrope walking skills. He also often uses *spider climb* to perform feats.

Splatter expects to one day establish a non-clown persona in Ravens Bluff, although the name and face will not be Lionel's. As long as Lord Charles has power, "Lionel" must remain in hiding.

The Big Top

The Flying Ringken

Fearless Ringken and his two assistants perform three different death defying aerialist acts and a midway magic act.

Ringken is a lean, dapper performer who likes to do the unexpected and keep the patrons on the edge of their seats, faking missteps and falls to be caught only at the last minute, and never doing the same bumbles twice.

The Flying Ringken's first act is performed on two trapezes, two hanging ropes, and a variety of jungle-gym type bars attached to the poles that support the trapezes. Ringken stages a series of cross-overs, flips, and maneuvers without the aid of a safety net. The catching trapeze and ropes are controlled by a cloaked and robed, runty roustabout.

The second act, The Web, is a network of single tightropes, one above the other, crisscross fashion. His act includes balancing, dancing, sword fighting, blind walking, and more.

The third act, Tumbling Trio, involves Ringken and his two assistants performing with whips, batons, balls, rings, and knives as they tumble, balance, and are tossed into the air and caught by the robed roustabout.

The Ringkens often are the high point in the Big Top show. His two assistants are a female illusionist and a disguised female korred. Delishe the illusionist acts as announcer, and casts *phantasmal force* during the performance to create spectacular special effects for stage dressing. These include mobs of fluttering birds, strokes of lighting, and anything else the two can agree on.

Mockingbird the korred wove all of the ropes used in the acts from her hair and can animate and control them from the ground. Further, should Ringken suffer a mishap, she can catch him and toss him back aloft with one of the ropes.

When not performing for the circus, Ringken and his assistants stage special performances at homes in town.

The Fearless Ringken is actually a master thief, and the team uses the cover of the circus to commit carefully-executed crimes in the towns they visit. Ringken does the actual stealing – climbing and lockpicking to gain access to homes. Usually, Mockingbird assists him, speaking to walls about secrets they may conceal, animating statues, and reshaping or walking

through stone to enter and exit locked rooms with no one the wiser. Delishe uses her illusionist abilities and disguises to cause distractions during the theft and to implicate others if need be.

They prefer to steal small portable valuables from people who can afford the loss. If they are discovered, Delishe uses her spells to make their discoverer forget the incident (*forget, suggestion, hypnosis* spells). The team prefers to avoid fights and is quick to vanish after a crime. Their goods are concealed in the hollow roof beams of Ringken's gaily painted wagon.

Ringken

8th Level Male Human thief

STR: 14
INT: 13
WIS: 15
DEX: 18
CON: 13
CHR: 15
AC Normal: 4
AC Rear: 8
Hit Points: 36
Alignment: Neutral Good
Languages: Common, Korred, Circus Jargon

Weapon Proficiencies: Long sword, dagger, club, staff

NonWeapon Proficiencies: Disguise (14), juggling (17), jumping (14), tightrope walking (18), tumbling (18)

Magic Items: *Bag of holding*, (1,500 lbs size) *bracers of defense AC 8*

Thief Skills:

PP OL FT MS HS DN CW RL
 75 75 50 65 45 45 90 20

Appearance: Ringken is a clever, charming rogue. His hair is ebony and short cropped, and he displays a thin mustache and cavalier attitude. His performing garb is a gaudy crimson tights covered in spangles. His everyday dress is nondescript and oftentimes shabby. Ringken is 5' 7" tall and weighs 162 pounds. He is 31 years old.

Background: Ringken is a master thief who specializes in cat burglary. He conceals his nighttime business from Mooney, knowing that it would not be tolerated. Indeed, he uses his skill as a pick-pocket and thief to act as security for the circus, identifying petty thieves who seek

to pickpocket or steal from patrons or the circus.

Ringken is a gentleman thief, never stealing from those who can't afford it. He has a chivalrous sense of justice, and will often take steps to frame a local scoundrel who abuses the public trust – usually by framing that person for one of his own thefts. He prefers not to leave a signature at the scene of the crime, but will often send framed scoundrels a note from "The Hand of Justice."

Delishe

6th Level Female Human Illusionist

STR: 9
INT: 17
WIS: 14
DEX: 16
CON: 10
CHR: 17
AC Normal: 6
AC Rear: 8
Hit Points: 12
Alignment: Neutral
Languages: Common, Elvish, Korred, Circus Jargon

Weapon Proficiencies: Dagger, staff
Nonweapon Proficiencies: Appraising (17), dancing (16), disguise (16), spellcraft (15) tumbling (17), sleight of hand (17)

Magic Items: *Ring of protection +2*
Spells/day: 4 2 2 plus one illusion per spell level

Spell Books

Level 1 Spells

| | |
|-----------------------|------------------------------|
| <i>Audible Glamer</i> | <i>Cantrip</i> |
| <i>Change Self</i> | <i>Nystul's Magical Aura</i> |
| <i>Spook</i> | <i>Ventriloquism</i> |

Level 2 Spells

| | |
|----------------------------------|-------------------------|
| <i>Blindness</i> | <i>Blur</i> |
| <i>Fools Gold</i> | <i>Hypnotic Pattern</i> |
| <i>Improved Phantasmal Force</i> | <i>Invisibility</i> |

Level 3 Spells

| | |
|----------------------|------------------------|
| <i>Phantom Steed</i> | <i>Spectral Force</i> |
| <i>Tongues</i> | <i>Water Breathing</i> |

Appearance: Delishe, partner and wife to Ringken, is in fine form. She is a bronze-skinned, red-haired beauty. Her muscles

The Big Top

are well toned from exercise and acrobatics, like a fine clock. Delishe is dedicated to Ringken and possesses his same puckish humor and desire for justice. She is 30 years old, stands 5'2" tall, and weighs 121 pounds.

Background: A native of Ravens Bluff, Delishe uses her sleight of hand skill to augment her illusionist abilities to create a midway exhibit – "Madame Tensing's Mystical Moments" – a magic show that relies entirely on sleight of hand, misdirection, and stage magician illusions, not "real" magic. Ringken assists her act as the Masked Mute. The performance is given on a recessed porch on the rear of the Fearless Ringken's wagon.

Delishe seems to always be smiling and is quite charismatic, able to swiftly become the center of attention of any crowd. She has a passion to collect beautiful crystal objects and may possess one or two magic items in her collection. Despite her winning personality she has a vengeful streak and is willing to go out of her way to revenge a slight or theft from her.

Mockingbird (Lady Enots)

Korred

STR: 18(80)
INT: 12
WIS: 9
DEX: 13
CON: 16
CHR: 8

AC Normal: 5

AC Rear: 5

Hit Points: 24

Alignment: Chaotic Neutral

Languages: Korred, Common

Weapon Proficiencies: Club

Nonweapon Proficiencies:

Gem cutting (11), tumbling (13), catching (15)

Magic Items: None

Appearance: Mockingbird is a female korred. She sports the full beard and wild hair of her kind, and shouts whenever she talks. Despite her boisterous personality, she conceals her true nature, wearing long dresses to hide her legs and never openly using her special powers. As a part of Ringken's act, she portrays the role of a mysterious robed dwarf, her head wrapped with a turban and scarf. Mock-

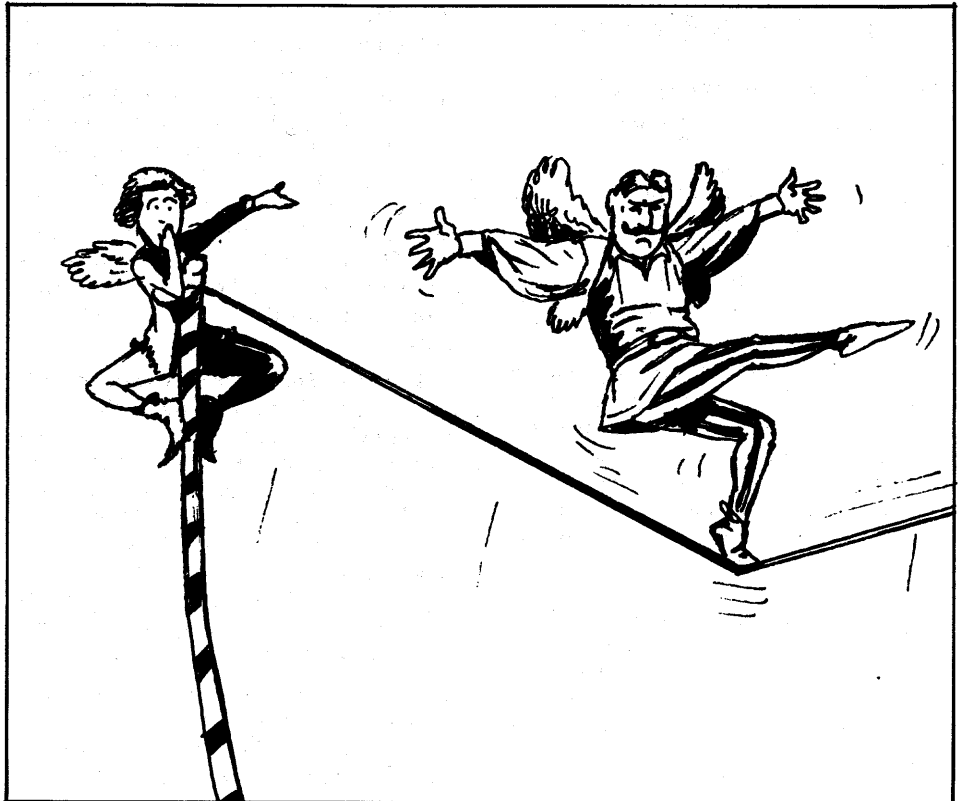

ingbird is 3' tall, weighs 142 pounds, and is 100 years old.

Background: Mockingbird has gone against known korred traditions because her original clan all died at the hands of marauders – except for Ringken who had been made an honorary member of her clan for services rendered. Her loyalties remain with him. The gypsy lifestyle of the circus fulfills her need for freedom.

Mockingbird doubles as one of the midway attractions – the bearded lady and her garden of wonder. In a world where bearded dwarven ladies abound, a bearded lady is humdrum. So Lady Enots displays her renowned sculptures. She creates her wondrous art using her *stone shape* skill. She pretends to use normal sculpting tools to conceal her natural ability.

Lady Enots' Garden of Delight is concealed in a small 20'x30' canvas tent. In addition to her statuary she decorates the area with artificial vines, flowers, plants, and models of tiny creatures made of woven, dyed hair. When the Lady Enots is present she can animate all of the items in the garden one at a time, surprising and delighting visitors.

Lady Enots's sculpting and weaving are so marvelous she often receives commis-

sions from wealthy patrons in the towns she visits. She willingly accepts the work, since it permits her to place one of her agents right in her patron's house to facilitate a theft.

New Proficiency

Sleight of Hand: This skill uses the character's Dexterity score as a base number. It can be used to palm small items making things appear and disappear from one's hands. A one third Dexterity check can be attempted to use *sleight of hand* to pick a pocket. Rogues who learn this skill add 5% to their pick pocket score for each slot spent (maximum 95%).

The Big Top

Using The Circus Put Some Sawdust In Your Campaigns

The Jack Mooney & Sons Circus can provide an endless number of adventures for campaigns set in the FORGOTTEN REALMS™ game world.

Below are some plot suggestions using the vendors, performers, and roustabouts included in this module.

Revenge Served On A Dwarven Platter: A bitter dwarven woman who has never forgiven Jack Mooney for throwing her and her ride out of the circus wants revenge. The dwarf never believed that her “mine cart roller coaster ride” was too dangerous – even though in its only day of operation the first three riders were injured. She has hired a band of thugs and thieves to plague the circus with accidents – tents collapsing, wild animals being set loose, trapeze wires fraying, etc. In turn, Mooney hires the player character adventurers to pose as roustabouts and get to the bottom of the trouble before the circus’s reputation is ruined.

Identity Crisis: Before Jack Mooney won the circus it was called The Full Moon Circus. The former owner died many years ago, leaving his wife copperless. The widow believes Mooney tricked her husband out of the only thing he loved in life – the circus. She has been following the circus for the past two years to familiarize herself with Mooney’s family. She noticed that Mooney’s daughter is a half-elf, who is too old of a half-elf to be sired by a human of Mooney’s apparent age (she didn’t know Mooney drank *potions of longevity*). She hires the group of player characters and pretends she is the real mother of the half-elven woman in Mooney’s family. She convincingly claims that Mooney kidnapped her half-elven daughter, used spells to make her forget her true home, and is keeping her at the circus only because he needs a cleric. She points out that Mooney is much too young to have a half-elven daughter that old. She offers to pay the PCs her life’s savings (which is 20 sp, but she doesn’t tell them that) if they would recapture her daughter. The woman intends to ransom the half-elf back to Mooney for a large sum of gold. If the PCs refuse to help her, she hires another group of adventurers to kidnap the girl. Then, Mooney tries to hire the PCs to rescue his daughter.

Oh, Rats! At the end of each circus engagement, the Pipers Song Pest Control Agency, which had been gathering rats during the week, has them teleported to a wilderness location. That’s normal procedure. However, this time Squeaky doesn’t return. Hamlin knows his teleportation destination – a forest several miles away. He hires the party to find Squeaky. The PCs will have to do a lot of cross-country traveling, as Squeaky got the spell wrong and ended up about 100 miles away.

Picking Up The Blame: A rash of pick-pocketing has been reported at the circus. The last victim is certain he saw a rat make off with his purse. Hamlin of the Pipers Song Pest Control Agency is suspected of the crimes, and arrested. Shazgrap, in human form, hires the PCs to prove Hamlin’s innocence. The real culprit is a wererat rival of Shazgrap’s – or, if the PCs are high level, a vampire who found the circus easy pickings.

A Dirty Byrrd: A cousin of Ramen and Reman Byrrd has heard of the twins’ success with the Jack Mooney & Sons Circus. He asked the twins to be cut in on the action, figuring that his family ties warranted a share of the wealth. However, the twins never cared for their cousin, and cared less for the idea of cutting their profits. So, they refused his request and sent him packing. Cousin Byrrd was not to be denied, however, and using his illusionary skills (all Byrrds tend to be wizards) he disguised himself as one of the twins and began causing trouble in the towns the circus played in. He used spells to damage taverns and businesses, he threatened women on the street, kicked puppies, and performed other evil acts. The local law enforcement agency could not find out if Ramen or Reman was to blame – so both were arrested. In the meantime, Cousin Byrrd went to the Ravenstar, convinced the crew he was Ramen, and directed the crew to take off. Jack Mooney hires the PCs to return the Ravenstar and capture the Ramen imposter, clearing the twins’ good names.

Beauty’s In The Eye: An evil wizard of Thay has tried for the past three years to coax the Mooney & Sons Circus into his city for a special performance. However, Mooney is not fond of powerful, evil magic users, and since Thay is full of them, he declined. The wizard decided to teach Mooney a lesson and followed the circus for several weeks to determine the best form that lesson should take. The

night the player characters are in the audience in the Big Top is when the wizard strikes.

The wizard has trapped Thanthal, the mage who poses as the beholder for the Doagar The Beholder Tamer act, in his *mirror of life trapping*. He releases a real beholder from the *mirror* and coaxes/compels it to hide in Thanthal’s box. Needless to say, the real beholder causes quite a stir when it appears under the Big Top. If the party is a high-level group, the wizard can hide in the audience and contribute to the general mayhem with his spells. In any case, Doagar is going to need a lot of help dealing with the real beholder – which should be readily evident to the PCs. If they help, the audience considers it all part of the act and has a good time. If the PCs don’t help, Mooney will have to dispatch the beast. After the commotion is over, Doagar realizes the female wizard/beholder is gone. Returning to his wagon he finds a mirror with the instructions, “break to release your friend.” When Doagar breaks the mirror the PCs will have more creatures to handle. See pages 174-175 of the DMG for details on the *mirror*. The DM should select additional denizens of the mirror based on the PCs’ abilities.

Romancing The Statue: A young child, wiping tears out of her eyes, approaches the PCs as they stroll down the midway and asks them to get her statue back. The little girl was at the Pick A Prize booth, pulled on a string, and won a beautiful statue that she was going to give her mother as a birthday present. She describes the man who took the statue. If the PCs investigate by going to the Pick A Prize booth, they see a teenage boy walking away dejectedly. “Stupid game,” he mutters. “I pay a copper and get a dumb statue. Lost my money. Lost the statue.” He, too, had his statue stolen. To find the culprit, the PCs will have to play the game until they win a statue, and the thief hiding nearby tries to take it from them. Or, they can watch the game until someone wins a statue and the thief runs up to steal it. The thief also played the game and won a statue with a piece of paper sticking out its base. Breaking the statue he found a piece of a genuine treasure map. The map piece was not sufficient, however, and he has been stealing statues from patrons in an attempt to locate another section of the map. If the PCs defeat the thief and take his map section, it will be up to them if they want to pursue the clue and find the treasure.

The Vast

Ravens Bluff and Environs

An accurate (but not verbatim) transcript of the following conversation with the famed sage Elminster is known to be part of the private collection of Charles Oliver O’Kane, Lord Mayor of Ravens Bluff. Perhaps it was knowledge gleaned from that transcript that prompted him to participate in the champions games, where the mayorship was the award for victory.

“What is it ye’d like to hear all about this time?” Elminster asked, leaning back to draw his pipe into smoky life.

I coughed, helplessly, and said with feigned innocence, “Well – The Vast, if you know anything of interest about it.”

The Old Mage’s eyes flashed. “Know anything of interest about it? ‘Course I do – and tell ye I will, if ye’ve more of this curious tea,” he peered into the depths of his cup. “And a lot more respect to tender my learning, youngling!”

I bowed my head, hiding a grin. “My humble and unreserved apologies, Greatest of Sages. Your learning is unequalled in two worlds, and you grace my best armchair and my awaiting ears in a way that evokes equal delight, while raising the honor of this household even as your presence is shrouded in secrecy. Our pleasant converse lights my days and gives purpose to my life, and for this I owe thee my deepest personal thanks. Those who will read what you’ve said, in this world around us, thank you also, in an ever-swelling chorus.”

“Enough, enough,” Elminster said in disgust. “Ye’re a smooth-tongued snake, when ye put mind to it.” He sniffed and settled into the depths of the armchair, drawing away from me – but his eyes twinkled. A puff or two later he began to speak about The Vast, leaning carefully forward to address my tape recorder more politely.

For those of you who’ve not met him, be warned: Elminster can (and will, given half a chance) talk for hours, on anything and everything. If you want to find out about something, be prepared to ply him with consumables, and to keep steering him back onto the topic you want to explore – unless you want to hear about everything else but your chosen topic. I managed to worm a little information out of Elminster about The Living City’s surroundings, and here it is.

Vastar: Orcs Rule The Vast

The sparsely-settled lands between the eastern shores of The Dragon Reach and the mountains to the north (around the Moonsea), east, and south (along the northern shores of The Sea of Fallen Stars, commonly called “The Inner Sea,” are collectively known as “The Vast.” The name’s origin has been lost with the passage of time, but most sages believe that it derives from “Vastar” or something similar, a name in use when orcs ruled these lands two thousand winters ago.

In those days, men were not seen on the northern shores of The Inner Sea except in occasional exploring or raiding bands. Elves ruled the deeply forested western shore of The Dragon Reach, dragons laired about the Moonsea and held sway over its lands and the broad gulf of the Reach itself, and orcs ruled the eastern shore of the Reach. Their government was one huge brawl with constant coups, counter-attacks, and strife with other inhabitants of the mountains.

The fecund orcs’ birthrate allowed them to recover from even the bloodiest civil strife or dragon raid; orcs even grew so numerous as to force the whelming of raiding hordes every dozen summers or so. These great, undisciplined hosts of warriors would build or seize ships and sail away south to plunder and slay. Few ever returned, the survivors spreading out across the warmer, richer southern Realms, and so the overcrowding of Vastar was regularly relieved.

To build their crude, ramshackle ships the orcs felled the timber of The Vast until none remained and they had to seize it from the elven shores across the Reach. The orcs soon found that if they sailed across the storm-torn Reach without securing a landing place first, they were doomed to a swift death under elven arrows and magic, ere they could land. So in the years between hordes army after army crossed the River Lis, then known by its elven name of “Nuathlis,” at the northern end of the Reach. Time after time these armies found elves waiting for them. Hails of arrows falling on orcs slogging through the marshy banks of the Lis brought great slaughter, earning the Lis the nickname “Blood River,” still used by orcs today.

In this, and in crude farming, fishing, and mountain hunting to feed themselves (leavened with mining and the forging of weapons), the orcs of Vastar occupied

their time. Proud and reckless, they often mounted raids to seize goods in short supply, but never raided to weaken enemies gathering strength nearby, nor worked any diplomacy or trade with the surrounding lands.

The Coming of the Dwarves

In the end, the proud orcs fell. Dwarves, mining in the mountains, came west and south underground, following veins of good ore, and met with the orcs in the lightless ways of the depths. After the initial skirmishes, the dwarven war councils determined that no orc who had seen a dwarf in the mines must be allowed to live, so that no word of any organized foe would get back to the orc chieftans. Lesser goblinkin (mainly goblins and kobolds) enslaved by the orcs to work the mines were ignored by the dwarves – so they never told their cruel orc masters of dwarven activities they saw, or aided their overseers when the dwarves came slaying.

The deaths of many orcs in the mountains were ascribed to the great struggle for the throne of Overking. The throne had been created by a monstrous orc known only as Ologh and left vacant when Iyrauroth, a great wyrm black dragon, slew him. Warring factions among the orcs fought each other up and down Vastar for eight blood-soaked years, until Grimmerfang defeated the last of his rivals and renamed Ologh’s court of the Hollow Mountain “Mount Grimmerfang.”

The mountain was to be his tomb. The dwarves had worked in secret with a few men and elves to develop a steel whose bite was poison to orcs, and with its aid broke out of the mountain caverns to “run in waist-high riot across the land,” as the sage Fairin Icemantle wrote.

Fairin had grave misgivings about the use of the “orcslayer” metal, fearing it would be only the first step in the making of many alloys harmful to other races – and bring, in the end, the ruin of all; his *Treatise Against Blood-Metal* survives in libraries in Sembia, Cormyr, Waterdeep (and perhaps still, in the ruins of Myth Drannor), giving the only first-hand account of the dwarven victories.

The secrets of making the deadly blades, and even just which mountain is Mount Grimmerfang, have been lost over the years. The few dwarven elders who still can identify the mountain do not speak of it to men. Elminster tells me that

The Vast

he's never investigated in person, but believes it to be the first peak north and east of Mount Wolf (see below).

The victorious dwarves drove the orcs far north and south into the mountain heights, claiming all The Vast as their own. "The Realm of Glimmering Swords," dwarven songs call it, though it may have had a less-grand, everyday name. They built stone towers, and brought herds of goats, sheep, and shaggy cattle from south across The Inner Sea to roam the grasslands cleared by the orcs. The dwarves occupied themselves in making fiery, legendary drinkables – and drinking them – and in making wondrous armor, finery, adornments, and weaponry with their metals. Little of this work would they part with in trade – just enough to buy more livestock. They also bought honey, which many dwarves love, especially in mead, from halflings who dwelt in woodlands here and there along the shores of The Inner Sea.

A few men came to live in the region at this time, notably the powerful mage known today as Maskyr the One-Eyed; his vale now is the site of the human village of Maskyr's Eye (see POLYHEDRON™ Newszine #54).

But the rule of the dwarves was short-lived, perhaps forty years in all. Orcs "breed like nothing else on or under Faerun; they put even hares to shame," as Elminster put it. All too soon, they rose again, and the power of the dwarves waned. The dwarves, under their king Tuir "Stonebeard," were defeated by orc bands at the fords of the Vesper, and in the battle of Deepfires. This infamous struggle raged though the underground ways of the mountains for twenty days and is still remembered in dwarven laments and sayings. One is: "I feel as if my axe was broken in the midst of Deepfires," often uttered by dwarves who are sick, depressed, or in pain.

Humans, coming by ship from the crowded southern lands around The Sea of Fallen Stars, began to settle south of the Fire River. The weakened dwarves retreated east and oversea southwards. Tuir was the last Deep King to claim the surface lands or even to be known of there. If an organized dwarven kingdom still exists in the area, it must be deep and quiet indeed.

The Vast in Human Hands

Humans spread rapidly across the Vast, clashing often with orcs and the wild creatures of the mountains, mostly leucrotta and trolls, who had grown numerous preying upon wounded and dead dwarves and orcs all across the war-torn land. Men cleared land for farms, collecting fieldstone into low walls and building good roads. Adventuring bands built themselves small keeps, and collected "shield taxes" from nearby farmers in return for a promise of protection against attack. Such defense (usually against orcs, trolls, and brigands) came by means of mounted warriors, bolstered by a minor battle-mage and a cleric of Tempus or Helm, but usually came too late.

Men, as one elven writer of the time put it, "breed almost as recklessly as the burners" [orcs]. Their swelling numbers, aided by immigration as much as by birth, soon pushed the former inhabitants and predators of The Vast back into the mountains and wilder foothills. There seemed a higher number of those who cheerfully seek out adventure among men than among the other races, too. Bards of The Vast sometimes call this "The Time of Glorious Fools," after the many adventurers who took on hopeless odds and, astonishingly, won almost as often as they perished. When good roads linked Mulmaster on the Moonsea and Procampur and Tsurlagol on the Inner Sea to the rest of The Vast, and several years of bountiful harvests followed, human rule of The Vast was assured. The ports of Calaunt, Tantras, and Sarbreen (later to become Ravens Bluff, The Living City) quickly found use by trading vessels from Sembia, Impiltur, Westgate and Aglarond. Traders came seeking farm produce and selling fine cloth, iron-work, locks, and weapons. The harbors became trade-stops in addition to their established uses as pirate rest and repair stops and immigrant-ship landing places. Men explored the nearer and more accessible mines in the area, and prospered further. Many of the larger farmers grew wealthy, bought up surrounding farmers, and began calling themselves "lords." These country gentry were often retired adventurers – or lost their lands to adventurers looking for a place to retire, and thus many of these petty lords today are folk of great personal power.

Among the most wealthy in the Fire River uplands, near Ravens Bluff, are Lord Thalmir of Mossbridges (a CN

human male 12th level wizard), Lord Malaph Serpentshield of Dark Hollow (a NE human male 14th level warrior), and Lady Estele Greymantle of Highbank Forest (a CG human female 11th level cleric of Eldath, dedicated to nurturing and rebuilding woodlands within her holding).

Although orcs and various monsters continue to infest the mountains, raiding down into The Vast now and then (especially during harsh winter weather), human rule of The Vast seems assured for now and years to come.

The Vast Today

The largest settlements in The Vast are the cities of Ravens Bluff, Tantras, Calaunt, and Mulmaster. Ravens Bluff is detailed in the accessory LC1, *Gateway to Ravens Bluff, The Living City*; in this product, LC2; and in POLYHEDRON™ Newszine. Tantras is described in module FRE2, *Tantras*. Calaunt is a sinister place, detailed in the *FORGOTTEN REALMS™ ADVENTURES* hardcover rulebook, which also contains information on Mulmaster.

Many rural folk of The Vast view Ravens Bluff as a colorful, dangerous place rife with intrigue. Tantras is seen as a safer place, dominated by the followers of the god Torm. Calaunt is viewed as a den of thieves, dominated by arrogant idiots (any such person may be called a "Calaunt-head" by Vast folk). Mulmaster is generally thought to be full of harsh cheats and tight-fisted people.

I asked Elminster about the lesser-known countryside of The Vast, places less well covered in print. He snorted and made some remark about "mapping every manure-pile between two seas," but in the end gave me far more Realmslore than I could squeeze into these pages.

The Countryside

The countryside is rolling farmland, fields used for all manner of crops and for grazing. Low stone walls divide the fields, and where a farm fronts on a road, the walls often are backed by thick, wild hedges. Woodlots have been left here and there among the farms, although they and the trees in them are small. The lots have grown from the scrub left behind by orc treecutters. Small brooks and streamlets are plentiful, but these seldom join larger rivers. Instead, they tend to drain into pools, and thence by underground

The Vast

ways seep down towards the sea, only to spring up later and repeat the process. Broken, tilted layers of rock underlie the deep soil of The Vast; dwarves say that it looks like a vast cauldron of ice chunks was stirred and then allowed to freeze, the “ice” caught at every angle. Sinkholes, caves, and rifts are plentiful but very small; local farm children often can hide from visitors in an empty field by using a person-sized hole they know of. Many farmers hide their wealth in such holes, while others build privies over them.

Where the farms end, proper forest begins, broken by occasional stone outcrops as the foothills rise up into the mountains.

Hunting

Boar, deer, and black-masked bear roam the forests of The Vast, and can be found, well roasted, on local tables. The Vast is known around the Inner Sea lands for roast stag, the meat being of the highest quality and size. Traditionally, this dish is served on large platters, the first bearing the full rack of antlers to the table, surrounded by sweetmeats and choice cuts.

Hunters say that game has remained surprisingly plentiful over the years. Most sages specializing in such things believe that the High Country has acted as something of a protected breeding ground, and only the rich food offered by farm plantings brings the choice game down into the farmlands, where the woodlots and wilderland groves offer shelter between feasts.

Most hunting is done in the wooded areas, either a few archers on foot, or four or more stout men armed with spears, daggers, and clubs, hunting with trained dogs. The first method requires more skill and delivers game in better condition.

Hunting in the foothills and on the wooded mountain flanks always has been a more dangerous game, undertaken only by large, well-armed bands. Wolves, orcs, brigands, and monstrous creatures have always attacked overbold hunters in the hills. In the fey, mist-cloaked marshes of the Flooded Forest, on the northern edge of The Vast, strange and dangerous creatures have recently begun to appear. Owl-bears, stirges, and other, rarer creatures that local hunters have never seen before and that have no local names have increasingly been met. Hunting near Ylraphon is now done in large, well-armed bands, who never camp the night

over in the woods, but return by torchlight with ready swords.

Customs

Folk in The Vast tend to keep to themselves, and see themselves as one with the land they inhabit. The countryside is beautiful but dangerous, and from their earliest days humans in the rural Vast go armed. Even the youngest child allowed out of mother’s reach has a sling or darts, and a belt knife.

Most folk in the Vast are contented with their homes and their lot in life, but they are always eager to hear news from the wider Realms. Such news gives them much entertainment, and they also enjoy ballads – even ballads they’ve heard a hundred times before.

Local bards of distinction are few, but many bards who wander Cormyr, Sembia, The Dales, and The Vast prefer the eastern side of the Reach above all else. “They treat ye as a friend, as an honored guest, and as someone deserving good coin and the best food,” said one. “Whenever I come into an inn, even if there be five or six harpers already gathered, smiles light faces of folk there, and they call out to me as if I were an old friend. Soon, of course, I was an old friend to most of them. I’ll keep walking those roads until I’m too old to walk anywhere.”

Wandering minstrels who frequent The Vast include the sharp-tongued and keen-witted Nalabar of Selgaunt, the jovial and well-loved “Happy” Mamblat of Hillsfar, and the beautiful half elf lady Sshansalue “Wonderharp.”

Several unique, festivals are celebrated throughout The Vast. These tend to be more energetically celebrated in the country, and paid less attention in the cities.

The Arming (the fourth day of Tarsakh) commemorates the rise of the farmers and merchants to defeat raids of tribesmen from the mountains south of Ravens Bluff, orc raids along The North Road, and brigand and pirate attacks throughout The Vast. On this day militias are mustered and inspected, weapons are worn proudly and well polished, youths of both sexes are given gifts of weapons or armor, weaponry contests abound, and feasts are held in which the ballads of the heroes are sung, and the tales of deeds of valor are told.

The Plowing (Mirtul 6th) is a day when the ground is broken for planting all over The Vast. Local teams travel about to break ground wherever desired, for free.

Casks of beer aged over the winter are opened in an evening feast, and the free plowing continues for four days if necessary.

Hornmoot (Kythorn 14th) is the traditional first trading day of spring between humans and dwarves. The dwarves once blew horns in the mountains to signal their coming, and men replied with horn-calls of their own if their settlements wanted to trade. Dwarves still come to these moots – and monthly ones from Kythorn through Eleint, always on the 14th of the month – each year, but each year there are fewer dwarves. Traders still come from as far away as Amn to get good axes and swords from the Stout Folk at these moots.

The Bone Dance (Highsun 9th) is a hunting festival. Clerics of Malar hold feasts after dark. These include pageants where bones of huge stags and other beasts are magically animated to enact hunts; very young and very old hunters in each community take the parts of the slaying hunters. Much food and drink is consumed, and on the next morning expeditions set forth to track down and slay any predators or dangerous monsters known to be active in the vicinity.

Temples & Clergy

All major human faiths can be found in The Vast. The cult of Torm is notable. During the time of troubles he came in person to his temple in Tantras, and his fall devastated an area north of the city walls – leaving it a field of twisted and tortured rock where no magic works, and spellcasters of all races feel sick or faint. Chauntea and Eldath also are commonly venerated.

The “travelers’ gods” – Tymora, Tempus, and Waukeen – are found in The Vast as they are everywhere. Temples to all of these gods can be found in the cities of the vast. Shrines to them all can be found throughout The Vast.

Shrines dedicated to Tymora, for example, are found in Maskyr’s Eye, King’s Reach, and High Haspur – all administered from a small temple in Mulmaster. Tsurlagol, Calaunt, Tantras, and Ravens Bluff all have temples of Tymora of their own.

Just as in the agricultural lands nearby (Sembia, Cormyr, and the Dales), The Vast is a place tolerant of many religions, although shrines and temples to other gods are few and far between outside the cities. Here and there along The North

The Vast

Road stand boulders etched with the crossed battle-axes of Clangedin, Father of Battles – and many local warriors pray to both Clangedin and Tempus before they go to war in the mountains.

Inns and Roads

According to most travelers, the best inns in the area are not found in the cities or even in The Vast proper, but in the wilder stretches of road linking The Vast with neighboring cities. Arguably the best of these is *The Wizard's Hand* in Maskyr's Eye; close behind come *The Worried Wyvern* in Sevenecho, and *The Elf In Armor* in High Haspur.

The *Hand* is some 80 winters old, and is named for the vanished wizard Maskyr. The *Wyvern* is not quite 20 years of age, and dominates the hamlet of Sevenecho (named for the family of the innkeeper). Sevenecho is located where the main overland road from Procampur meets the Turlagol Road.

The Elf in Armor is named after the elven warrior Beluar, who aided the dwarves of Tuir's fading kingdom in their battles against the orcs. Beluar and his small band of elven riders perished in an orc ambush in the mountain pass south of Ravens Bluff, known ever since as Elvenblood Pass. Beluar is buried in the hamlet just south of that pass, Sarbreenar. From there, the High Trail runs south to High Haspur, where it forks to run straight south to Procampur, and to run southeast toward Turlagol, and a junction with the main North Road.

Beluar's most famous victory over the orcs came at Viperstongue Ford. Beluar's forces routed the orcs, pursuing them north into a rugged line of hills southwest of Kurth, and thence north along the road as far as Maskyr's Eye, where Beluar himself slew the last of the orcs on the road outside the town smithy. The hills west of the road, between Kurth and Maskyr's Eye, are sometimes called Beluar's Hunt. There is an inn of that name in Kurth, and the rival *Rolling Heads Inn* at the other end of the same town is also named for the routed orcs.

Travelers on the North Road often measure their progress by the mountains. South of Maskyr's Eye, the border of The Vast proper is marked by Mount Wolf, which towers above the road. Many wolves laired near the peak years ago, until local hunters saw them as far too efficient competition for the highly-prized stags, and largely wiped them out.

There are no known passes through the mountains from The Vast to eastern lands south of Mount Wolf, although rumors persist of hidden ways through the peaks from the easternmost reaches of the High Country to Impiltur. The range of peaks that wall in The Vast on the east are sometimes called the Giant-spike Mountains.

To the south, the road runs through the market town of Kurth, and into Three Trees Pass. The mountains on either side of the pass are sometimes called the Troll Mountains, although few trolls are seen there today. They have been almost eradicated by dwarves, who live in mines high above the Pass – once-rich mines that now yield only a little iron and less copper.

South of "the High Reach," a nickname used to distinguish the town of King's Reach from The Dragon Reach, which divides The Vast from the Dales, the road leaves the mountains and crosses rolling hill country. Its route roughly divides the walled farms of The Vast from the High Country, a large expanse of grassy hills and rocky moorland inhabited mainly by shepherds and their flocks.

Several small stopover camps are found along the North Road as it crosses this rolling open land, each by a pond or stream. At least two of these sites boast inns, *The Nine Swords* at Swords Pool, and *The Blue Stallion* at Dead Tree Hollow.

Dragon Falls

The largest settlement along The North Road between King's Reach and Turlagol is the village of Dragon Falls, named for a spring-fed stream that cascades down a bluff beside the road, then runs down to the Fire River. Of old, it was the lair of a fearsome red dragon. Some say that the Fire River's name comes from the devastation this great wyrm wrought on orc, dwarf, and human settlements up and down the river through the years. A human adventuring band finally slew it. The band built a stronghold that became the fortified *Inn of the Dragon*, and the center of a growing village. The Hlinter Ride joins the North Road at Dragon Falls.

The High Country

Local legends – even in the days when orcs ruled – have always held that the High Country was home to sometimes invisible "little people" (sprites), and

although a wanderer in the High Country will rarely meet these quiet folk, there are areas – particularly small, hidden dells crowded with old, moss-covered trees and sparkling pools – that prudent shepherds avoid. If weather or mischance brings an experienced shepherd into one of these areas, their custom is move quickly and quietly, light no fires, and cut no trees. They depart quickly and leave behind one or two sheep, tethered to a stake, with a loudly-spoken but humble apology for trespassing. The less prudent take their chances, but fewer return to bring back tales of the hidden dells.

Sheep-trails crisscross much of the High Country, but the sprites tolerate few buildings. Most shepherds use simple, temporary turf huts. A few lonely, widely-separated stone towers standing in the easternmost reaches of the High Country are said to belong to powerful, reclusive mages, who the sprites leave unmolested because they turn back most of the orc bands that wander down from the surrounding mountains.

Hlinter

This small crossroads town is ruled by a Master Merchant, head of a council of eight merchants, and is known for its finely trained horses, bred locally. It is also home to several large and muddy pig-farms.

Almost a hundred winters ago, a greedy and ambitious Master Merchant of Hlinter, one Marakus Beindold, sought to enrich his coffers and expand Hlinter's farms into the hills east of the town, traditionally claimed by the dwarves. He invited the dwarves by special letter to Hornmoot in Dragon Falls, which his hired mercenaries forcibly occupied before the dwarves arrived. The merchant welcomed the dwarves and feasted with them, plying them with drugged wine – then had them butchered in their bedchambers during the night.

Only a few dwarves escaped, but enough eluded the Master's guards to return 10 nights later to catch the merchant in his bed chamber and break all his joints with their hammers. He was found dying the following morning and was rescued only through the heroic (and expensive) efforts of several local clerics.

That was the last Hlinter has seen of dwarves from that day to this. No dwarf of The Vast will knowingly and willingly set foot in Hlinter, nor trade dwarven

The Vast

work with a merchant known to trade there.

King's Reach

King's Reach is a wealthy, fortified town that has always served as a center for metals trade. Miners bring ore to smelt, and smiths bring worked metals smelted elsewhere. Other merchants bring goods by barge upriver from the Reach, to trade with the miners and smiths.

King's Reach marks the highest navigable point on the Vesper. Above the town, the Vesper's chill, clear waters are broken by a long series of rocky cascades. The town is named not for the reach of any human king into the dwarven lands, but for the fact that Tuir, king of the dwarves, decreed that this far into the mountains – and no further – would men be permitted to reach. Other origins for the name have been given, but most sages agree that this is the oldest, and is probably true.

Kurth

This farm-market town is often short of water; its two mills both use recycled water, magically recirculated and filtered many times. It has a brewery, a large stockyards, and a wheelwright of distinction, but is otherwise unremarkable.

Townfolk have recently seen walking skeletons, carrying swords, in the overgrown grounds of Feljack's Hall, a ruined mansion on the western edge of town. No locals have cared to investigate further. Persistent rumors in Calaut and Tantras whisper that Kurth is a place where much treasure is hid, for many pirates come here to retire, and much shady business goes on in the quiet backrooms of the town and in *The Gauntlet and Girdle* tavern.

Kurth was named for its founder, a grim, axe-wielding adventurer friendly to the dwarves. His nickname was "Bandit-Slayer," and it was well earned.

Ylraphon

Ylraphon, pronounced "Ee -yil -ra- fon," was once an elven city, then a ruin where an orc chieftan held court, then a dwarven city, then orc-controlled ruins again. Now it is a small port whose northeastern reaches are ruins, fast overgrown by scrub and saplings. Local lore speaks of rich treasures buried in Ylraphon by raiding orcs and fleeing dwarves.

Welcome to The Vast

I look into my files, and see that there's more to be told about the dwarves, and much about Maskyr's Eye and the vale in which it lies. There's also the story of The Mage's Tower (a good place to avoid) to be told, some day.

That's it; when I asked for more, Elminster just grinned. He gave me a map that shows a lot of places I haven't even mentioned so far (such as Bambryn, Fallentree, and Tavilar). They, and The Vast in general, are yours to explore and develop. I'll be giving readers of the POLYHEDRON™ Newszine more information on The Vast, but these lands belong to you, fellow RPGA™ Network members, and I'll be watching the pages of the "LC" products and the Newszine eagerly in the months and years ahead to see what you do with them.

Please hurry. The Knights of Myth Drannor are becoming impatient; it's getting harder and

harder for me to distract them from sailing across the Reach and looking around!

Oops (ahem). Elminster's back, and leaning toward my tape recorder with what I can only describe as a fiendish grin. It looks like he'll be getting the last word (as usual).

Elminster's Parting Word

"So it's The Vast they'll want to be tramping around next, is it! Well, tell thy readers beware – there're beasts and secrets sleeping in those mountains that had best be awakened only by someone with a ready blade and fast spells, if they'd live to boast of it."

"Another watchword of the Realms springs to mind as fitting, too. Remember: bandits and orcs are always with us. Slay one and three stand up in the same place. Kill one at thy gate, and expect to find another waiting under thy bed. Conduct thyself accordingly, and live longer."



Inside Ravens Bluff

A Party In Embassy Row

Location: Ravens Bluff

Total Character Levels: 42-48

Total Wealth Available: Variable

Total XP: Completing 1st section, 702

Completing 2nd section, 4,200

Defeating the killers, 6,020

Set Up:

The Zhentarim ambassador quartered in Ravens Bluff is hosting a party tomorrow night. Guests include many other ambassadors in the city, their diplomatic staffs, Ravens Bluff dignitaries, and a few fortunate socialites.

Although ambassadors are prone to giving parties, Deputy Mayor Howard Holiday is concerned about this one. He assigns the player characters to watch the embassy today and tomorrow – right through to the end of the party. Holiday and others in Ravens Bluff's government have no use for Zhentil Keep and the evil Zhentarim.

The PCs will have to be careful on their mission, as they cannot legally enter the embassy grounds uninvited – knowing the Zhentarim such a misstep would constitute an act of war. Therefore, the PCs might have to observe the embassy from a position across the street, keep tabs on what appears to be going on, and report anything suspicious to the deputy mayor. Further, Holiday instructs them to prevent anyone from entering the embassy who doesn't look like a party guest.

About the only way the PCs can sneak into the embassy is to capture a few people going to the party, dress in their clothes, and use their invitations to get past the gate guards. If the PCs openly discuss such a plan, Holiday will discourage it, as it isn't legal to impersonate dignitaries.

The PCs will receive 25 gp up front for the assignment, plus a bonus later when the party is over.

The following nations or cities have embassies in Ravens Bluff: Algarond, Amn, Cormyr, Calimshan, Chessenta, Evereska, Evermeet, Impiltur, Lantan, Moonshaes, Mulmaster, Rashemen, Sembia, Thay, Turmish, Waterdeep, and Zhentil Keep.

The Plot:

There is indeed foul play planned for the party – but not by the Zhentarim. A eight-member delegation (death squad) from Mulmaster, which cannot stand the Zhentarim ambassador, will seek to commit several murders and put the blame on the Zhentarim. The delegation hopes to increase the distrust felt toward Zhentil Keep by people in Ravens Bluff and nearby cities.

Because the delegation is taking every precaution they deem possible, the PCs will not recognize them as anything other than party guests. The delegation will get into the embassy unless the PCs are searching everyone who tries to enter the Zhentarim building.

The Mulmaster delegation is sneaking weapons and disguises into the party. An hour into the affair, delegation members are to individually excuse themselves to “freshen up,” don disguises to make themselves look like Zhentarim, re-enter the main banquet room, and kill as many guests as possible. The first target is the Thayvian ambassador. During the confusion the delegation members are to skulk back to the Mulmaster Embassy.

If the PCs were not able to get into the embassy, they will not be able to prevent the murders. However, they can – and should – follow the escaping Mulmaster delegates to their embassy. The PCs could be confused, however, as the delegates look like Zhentarim agents.

- If the PCs opt to fight the fleeing delegates, the delegates initially try to bluff their way past, then try to continue their escape. They fight only as a last resort. They will not allow themselves to be taken alive. If the delegates make it to the Mulmaster embassy, they quickly change clothes, leave, and lose themselves in Ravens Bluff's side streets.

- If, instead, the PCs take a passive approach and report to Howard Holiday that Zhentarim agents were seen running from the embassy and therefore probably were the troublemakers, they will be each rewarded 150 gp and told that city officials will take it from here. However, one week later Howard again approaches the PCs and demands that they each give the 150 gp back because the Zhentarim are not involved. If this is the case, the PCs have few alternatives: give the gold back, get kicked out of the city, or continue the investigation.

- If the PCs choose to investigate the murders on their own – whether it was

their own decision or because they were spurred on by Howard – proceed to the next section.

PCs who inform Holiday that they are investigating the murders will be vouchsafed by Ravens Bluff officials as special agents of the government and will be permitted by the Zhentarim and most other countries' ambassadors to question people about the murders. This allows the PCs to temporarily ignore the sovereignty of the embassies and their staffs. The only embassies that will not permit the PCs any privileges are Thay and Mulmaster.

A Second Twist

The morning after the murder the Thayvians, who likely are now minus one ambassador, attempt to exact compensation from Zhentil Keep – 20,000 gp, and from Ravens Bluff – 16,000 gp. The Thayvians do not reveal to anyone in the city that their murdered ambassador has been sent back to Thay to be raised. If the PCs ask to examine the Thay ambassador's body, they will be told it has been returned to his family. All the other murder victims are laid out in the Zhentarim embassy awaiting burial or raising, depending on their status.

City officials are enraged that the Thayvians would attempt to get gold from the government. Holiday again contacts the PCs and pushes for their investigation to proceed.

- If the PCs question ambassadors who were at the party, refer to the ambassadors' and other NPCs' statistics at the end of this adventure to determine what the PCs learned.

- If the PCs question representatives and servants at the Zhentarim embassy, and ask the correct questions, they will learn that all of the Mulmaster delegates disappeared prior to the attack.

- If the PCs attempt to question the staff at the Mulmaster embassy, they will be treated rudely and get little information. However, shortly after their attempt the Mulmaster gardener approaches them and offers to sell them information for 100 gold pieces. If the PCs meet the price, the servant tells them the Mulmaster delegates were seen leaving the Mulmaster embassy with Zhentarim disguises in tow.

- If the PCs uncover the Mulmaster crime, they will be given 2,000 gold pieces from the Zhentarim, 1,600 gold pieces from Ravens Bluff officials, and the Mulmaster ambassador and his staff will be expelled from the city.

Inside Ravens Bluff



Cast of NPCs

Lunessa Redmon, Ravens Bluff merchants guild representative, 0 level female human: STR 15, INT 15; WIS 17; CON 9; DEX 16; CHA 13; MV 12; hp 6; AC 8; AL Neutral Good; S M; THAC0 20

Lunessa never had been inside a foreign embassy before and had asked the merchants guild if she could be the representative to this party. She regretted being pushy about it, as she was nearly killed. She is certain the murderers were Zhentarim, as the attackers wore clothes similar to the other Zhentarim in the room.

Malagar Flamhart, council of lords representative, 0 level male human: STR 12, INT 12; WIS 16; CON 9; DEX 9; CHA 16; MV 12; hp 6; AC 10; AL Neutral Good; S M; THAC0 20

Malagar was moving up in the council of lords until he attended the party and was the second person killed in the assault. He will be raised at the expense of the council. If the PCs wait to talk to him after the raising, he tells them he was eating a crab puff when he was stabbed in the side by someone in Zhentarim garb. He

doesn't remember anything else. However, he adds that he hopes the PCs are able to catch the "vile rogues."

Stanbier, Mulmaster ambassador, 0 level male human: STR 7, INT 15; WIS 15; CON 6; DEX 6; CHA 17; MV 12; hp 4; AC 10; AL Neutral; S M; THAC0 20

Stanbier is a fat, jovial diplomat who appears to be about 40 years old. He never discusses his age. He is witty and charming, but he can be tough when necessary. He will not be harmed in the attack at the Zhentarim embassy, but his escort, Selere, will be killed for appearance. Selere was a local courtesan who was often seen with Stanbier; he will see to her burial. Stanbier will be otherwise unaccompanied at the party.

He has an embassy staff of four; a cook, housekeeper, caretaker (who also gardens and does limited guard duty), and a clerk who is always busy. From time to time various Mulmaster natives are at the embassy, such as the eight-member Mulmaster death-squad.

Stanbier will act friendly toward the player characters – as long as they do not threaten him. He is a coward at heart and will wilt quickly if confronted with the evi-

dence of the fleeing assassins seen entering his embassy.

Clartil Crumnert, Amn ambassador, 0 level male human: STR 10, INT 16; WIS 16; CON 8; DEX 9; CHA 17; MV 12; hp 5; AC 10; AL Chaotic Neutral; S M; THAC0 20

Clartil is a swarthy man with a bright personality and a tongue that gets him into trouble as often as it gets him out of it. He frequently opens his mouth before thinking a problem through and has caused Amn one or two embarrassments throughout his career. He has had more postings and can tell more stories than any other ambassador stationed in Ravens Bluff. He and his wife, Marla, will be killed at the party, but will be raised within 24 hours, when a high-level Amn cleric is summoned. Clartil will be revived, but will be too devastated to be of much help to the PCs. Marla will not be able to be raised.

Oswal Stumm, Clartil's assistant, 2nd level male human cleric: STR 9, INT 16; WIS 18; CON 12; DEX 12; CHA 8; MV 12; hp 12; AC 8; AL Chaotic Good; S M; THAC0 20; spells in memory – *cure light*

Inside Ravens Bluff

wounds, detect evil, detect magic, detect poison.

As Aide-de-camp to Clartil, Oswal generally runs the Amn embassy and does his best to keep Clartil out of trouble. He will not be harmed in the attack, and he will use his *cure light wounds* on the nearest person who needs aid. He recognizes that Clartil and Marla are beyond his help.

Oswal is an excellent organizer, but he has a gruff personality that makes him unsuitable for a front-line diplomat.

He suspects that the killers were not the Zhentarim, but were impersonators. However, he has no proof of that. He is definitely suspicious of anyone who would flee their own embassy.

Galesh Megrorn, Thay ambassador, 5th level male human mage: STR 9, INT 18; WIS 14; CON 10; DEX 16; CHA 17; MV 12; hp 12; AC 4; AL Neutral Evil; S M; THACO 19; spells in memory – *Charm person, friends X2, sleep, forget X2, hold person*; magic item: *Bracers of defense AC 6*

Galesh is secretly a Red Wizard, currently loyal to the zulkir of necromancy. He is haughty and arrogant toward all whom he considers inferior, which is just about everyone. He is capable of diplomacy when dealing with other diplomats or other Red Wizards, particularly those who outrank him. Galesh will be killed at the party only because he won't be expecting any trouble. The PCs will not meet him unless they were able to get inside the Zhentarim embassy for the party. Galesh was attending the party alone. His staff consists of a cook, a groundsman, and a clerk (who will arrange for his raising). The clerk looks after most of the embassy's affairs.

The Thayvian embassy staff will not talk to the PCs unless forced. If they are forced, the PCs will learn the Thay ambassador had a fairly good relationship with the Zhentarim, and they can't image the Zhentarim jeopardizing any standing with Thay by killing Galesh.

Bolatar Zarim, Zhentarim ambassador, 9th level male human fighter: STR 17, INT 16; WIS 15; CON 18; DEX 17; CHA 16; MV 12; hp 90; AC 0; AL Chaotic Evil; S M; THACO 12; magic items: *Bracers of defense AC 3, ring of regeneration*

Bolatar is a man of vision who sees a day when peace will rule the Realms (and Zhentil Keep will rule peace). He is an excellent diplomat with a silver tongue. The thought of someone framing his people will outrage him, and it will be several hours before he is calm enough to talk

civily to the PCs. He will point out that if the killers were Zhentarim, they would not leave the grounds.

Zhentil Keep Embassy Staff

Kindrak Kindrakson, head of house, 0 level male human: STR 10, INT 14; WIS 16; CON 8; DEX 9; CHA 13; MV 12; hp 5; AC 10; AL Chaotic Evil; S M; THACO 20

He is horrified that such an incident should occur at the embassy, especially at one of "his" parties. He will remain cool and calm on the surface, setting a good example to those who panic. He will render first aid when appropriate and will take charge of the situation. He can provide the PCs with little information, other than confirming that there were no uninvited guests attending the party.

Beidler and Githon, hired waiters, 0 level male humans: STR 15, INT 10; WIS 12; CON 14; DEX 12; CHA 11; MV 12; hp 4 each; AC 10; AL Chaotic Neutral; S M; THACO 20

Beidler and Githon have worked at the Zhentarim embassy for parties twice before, and never had any trouble. They plan never to work here again. Beidler was in the kitchen looking over the food when the attack came. He hid next to the oven until the commotion stopped. However, he will tell the PCs one of the assassins – most assuredly an evil Zhentarim – clubbed him on the head as he ran outside to call for help to stop the murders. Githon was in the ballroom and was slightly injured in the fight. He will be more talkative if the PCs cure him. Githon saw the Zhentarim agents enter the main ballroom from different areas. They didn't walk like Zhentarim, and they didn't sound Zhentarim when one said, "We got the Thay man, let us leave." However, Githon can't quite place the accent.

Sendira, hired waitress, 0 level female human: STR 8, INT 12; WIS 9; CON 9; DEX 9; CHA 18; MV 12; hp 6; AC 10; AL Neutral; S M; THACO 20

Sendira works for the same firm as Beidler and Githon. She saw the killers leave the party (she was hiding behind a curtain). One of the killers looked familiar to her – she saw him a few days ago in the Mulmaster embassy where she was interviewing for a position. She refused the job when she discovered that more than waitressing was expected. Sendira does not

like Stanbier or anyone else connected with the Mulmaster embassy. She does not know the killers were instructed to execute her, however her hiding place behind the Curtains kept her safe. Stanbier wanted her dead for refusing his advances.

Gorfred, groundsman, 0 level male human: STR 10, INT 16; WIS 16; CON 8; DEX 9; CHA 17; MV 12; hp 2; AC 10; AL Neutral Good; S M; THACO 20

Gorfred saw the killers flee the embassy and turn left. He is a drunkard and can't reveal any more information to the PCs. However, he will be friendly and invite the PCs to share a drink or three with him.

Makira, the cook, 0 level female human: STR 7, INT 16; WIS 16; CON 9; DEX 18; CHA 10; MV 12; hp 6; AC 6; AL Neutral Evil; S M; THACO 20

Makira was in the kitchen throughout the assault and did not witness anything. If the PCs press her, she admits that once the shouting started she hid with Beidler next to the stove. If any of the PCs seem undernourished, she tries to get them to eat something. However, if the PCs are rude to her, she tries to get them to eat something tainted with special herbs; this food will cause any PC who ate it to subtract three points from his Constitution score for three hours.

Sylvester, clerk, 0 level male human: STR 7, INT 12; WIS 18; CON 7; DEX 16; CHA 14; MV 12; hp 4; AC 8; AL Neutral Evil; S M; THACO 20

Sylvester is a foppish young man who is bewildered by all of the day's events. If questioned harshly he will blubber, slobber, and apologize for anything and everything. He has no useful information.

Mulmaster Hit Squad

Angar Barkstykys, 10th level male human fighter: STR 17, INT 12; WIS 12; CON 17; DEX 16; CHA 11; MV 12; hp 94; AC 1; AL Chaotic Evil; S M; THACO 11; magic items: *Ring of protection +2, cloak of protection +2, long sword +3*

Hit Squad Members, 6th level male human fighters: STR 14; INT 14; WIS 10; CON 12; DEX 17; CHA 9; MV 12; hp 33, each; AC 5; AL Chaotic Evil; S M; THACO 15; magic items: each fighter is equipped with a poison-coated *short sword of quickness*; each wears leather armor.

Inside Ravens Bluff



The Vulture, Vernon Condor

Male Human Fighter/Wizard Level 4/12

STR: 16
INT: 18
WIS: 17
DEX: 12
CON: 12
CHR: 10

AC Normal: 0

AC Rear: 0

Hit Points: 49

Alignment: Lawful Good

Languages: Common, Dwarvish, Elvish, Halfling, Orcish, Lizardman, Gnomish, Hobgoblin

Weapon Proficiencies: Long sword, dagger, lasso, short sword, staff

Nonweapon Proficiencies: Reading/writing (18), appraising (18), tracking (17), ancient history (17), herbalism (16), religion (17), spellcraft (16), weather sense (16), Local History (10)

Magic Items: *Bracers of defense AC 0, ring of truth, ring of warmth, wings of flying, amulet of proof against detection and location, boots of elvenkind, eyes of the eagle, long sword +2* (detects precious metals, minerals, and gems in a 30-foot radius)

Spells/day: 4 4 4 4 4 1

Spell Books

Level One Spells

| | |
|---------------------|-----------------------------|
| <i>Change Self</i> | <i>Charm Person</i> |
| <i>Detect Magic</i> | <i>Message</i> |
| <i>Mount</i> | <i>Protection From Evil</i> |
| <i>Read Magic</i> | <i>Spider Climb</i> |

Level Two Spells

| | |
|-----------------------|-------------------|
| <i>Detect Evil</i> | <i>Knock</i> |
| <i>Know Alignment</i> | <i>Levitate</i> |
| <i>Magic Mouth</i> | <i>Rope Trick</i> |
| <i>Stinking Cloud</i> | <i>Web</i> |

Level Three Spells

| | |
|-----------------------|---------------------|
| <i>Clairaudience</i> | <i>Clairvoyance</i> |
| <i>Hold Person</i> | <i>Slow</i> |
| <i>Suggestion</i> | <i>Tongues</i> |
| <i>Vampiric Touch</i> | <i>Wind Wall</i> |

Level Four Spells

| | |
|------------------------|-----------------------|
| <i>Detect Scrying</i> | <i>Dimension Door</i> |
| <i>Polymorph Other</i> | <i>Polymorph Self</i> |
| <i>Wall of Fire</i> | <i>Wizard Eye</i> |

Level Five Spells

| | |
|---------------------------------|----------------------|
| <i>Bigby's Interposing Hand</i> | <i>Chaos</i> |
| <i>Feeblemind</i> | <i>Telekinesis</i> |
| <i>Teleport</i> | <i>Wall of Force</i> |

Level Six Spells

| | |
|-------------------------|-------------------------|
| <i>Anti-Magic Shell</i> | <i>Chain Lightning</i> |
| <i>Control Weather</i> | <i>Guards and Wards</i> |

Appearance: Although Vernon Condor stands 5' 11" tall, he appears several inches shorter because of his stooped shoulders. The 47-year-old Ravens Bluff native dresses in fine, tailored clothes, which appear expensive, but not gaudy. He favors browns and grays. Vernon began losing his hair 20 years ago, and is now completely bald. His facial features are pronounced – small, black eyes beneath arched eyebrows, high cheekbones, and a large hawk-nose.

Inside Ravens Bluff

Background: Vernon Condor, who is known to the public as “The Vulture,” was born to a wealthy Ravens Bluff family who made sure he received the best education possible. Condor loved schooling and immersed himself in law books and history books. Condor planned on becoming a lawyer or politician. However, a group of close friends encouraged him to see the world first. He adventured with his small group of friends for six years, becoming a skilled fighter and then switching his studies to magic. When his parents died he returned to Ravens Bluff to inherit his estate. He settled down and began to study again, specializing this time in economics, while at the same time increasing his magical knowledge.

As he observed and studied the Living City’s economy, he became impressed with the positive effects brought by Mayor O’Kane’s efficient and uncorrupt leadership. He began to form his own economic theories and started to advocate a strong, mercantilistic government with a steady income from an equitable tax system. Such a government, he reasons, is the only entity capable of maintaining all the city interests simultaneously. He also reasons that unfairness and corruption channels money away from vital projects and undermines confidence in the system.

By the time he was 35, local politicians began seeking Vernon’s advice on tax matters. Two years later he was appointed the city tax collector – a position he has held for 10 years. His official title is *Regent of the Excequer*.

Vernon is happier now than he ever was. He is surrounded by the things he loves most: money, laws, and power.

Vernon is a just official, greatly respected by the other city officials, admired by many in town, and feared and shunned by those who oppose taxes or who try to avoid paying them.

The Vulture’s policies are fair, with people taxed based on their incomes and personal wealth. The destitute and unemployed are not taxed, unless the unemployed are well off because of personal wealth and land.

The Vulture strictly enforces his policies, and he ruthlessly brings to justice all tax evaders, counterfeiters, and embezzlers he can find. He is in charge of a group of men and women who patrol Ravens Bluff in search of offenders. They also investigate counterfeiting, fraud, illegal gambling, and tax evasion. One of their current Vulture-directed projects is to keep an eye on the Jack Mooney & Sons

Circus. The Vulture never enjoyed circuses and is convinced that when the circus winters in Ravens Bluff Mooney brings in more money than he reports. (Actually Mooney reports his income honestly, but many of his people do not.)

Leaf in Root

Leaf in Root, a pipe and tobacco shop, is located in a small, red-block building between two other businesses. Leaf in Root is owned and operated by a halfling named Oscar Sodhome. Oscar also has an assistant, Chug Millman, another halfling.

Leaf in Root is famous both near and far for its exclusive pipes and unique tobaccos. Many people come from great distances for Oscar Sodhome’s “Sodhome Specials” – pipes made from a secret root and custom crafted by Oscar himself. Oscar makes most Sodhome Specials to his own liking, and they sell well enough. He can, however, be persuaded to carve a

custom pipe – if he is offered enough money. Oscar also makes a fair amount of money on common pipes, such as briars and clay pipes (although Oscar cannot understand how anyone can stand to smoke a pipe not made from a root).

Tobacco is also a big-selling item at Leaf in Root, both common and exotic varieties. Oscar keeps common types on hand, and he always has an exotic type as a weekly special. If requested, Oscar can get almost any type of leaf, no matter how rare or expensive it is. Oddly enough, Oscar labels each type of leaf with its supposed medicinal value; if nothing else, he is convinced that this helps sales. Along with pipes and tobacco, Leaf in Root also carries pouches, tinderboxes, and other smoking paraphernalia.

Leaf in Root is also a business where people can post notices either offering their services as hirelings or asking for the services of hirelings. Again, Oscar is certain that this helps attract new customers and bolster sales.

Wares and Prices

Pipes

| | |
|-----------------|--------------|
| Clay pipe | 5 sp-1 gp |
| Briar pipe | 1 gp-5 gp |
| Sodhome Special | 5-10 gp |
| Custom pipe | 20 gp-100 gp |

Tobacco (per pound)

| | | |
|----------------------|---------|---------------------|
| Weekly special | 4 gp | |
| Specially ordered | 2-15 gp | |
| Common | | |
| Gloaming Dark | 2 gp | cures coughing |
| Gloaming Light | 2 gp | cures headaches |
| Ancient Ash | 2 gp | cures fever |
| Burrowville Blueleaf | 14 gp | fighting tiredness |
| Misty Moss | 2 gp | cures ulcers |
| Wizard Weed | 2 gp | removes wrinkles |
| Laughing Leaf | 4 gp | increases merriness |
| Dungeon Delight | 2 gp | warms body |
| Oscar’s Only | 2 gp | aids eyesight |
| Nicotiana Night | 4 gp | aids sleep |

Miscellaneous

| | |
|------------------------|------|
| Tinderbox | 8 sp |
| Tobacco Pouch, Cloth | 5 cp |
| Tobacco Pouch, Leather | 1 sp |
| Pipe Cleaning Kit | 5 sp |

Nothing in the store is marked with a price. Oscar and Chug expect customers to name prices for the items they want. If the price offered is higher than what is shown on the table, the offer is accepted immediately (but not too hastily). If offered a lower price, Oscar and Chug

haggle with the customer until they can get an acceptable price; they will never go lower than the listed prices. Note, however, that retail customers seldom buy an entire pound of tobacco. A typical tobacco pouch (such as the ones sold at Leaf in Root) hold about 2 ounces of tobacco —

Inside Ravens Bluff

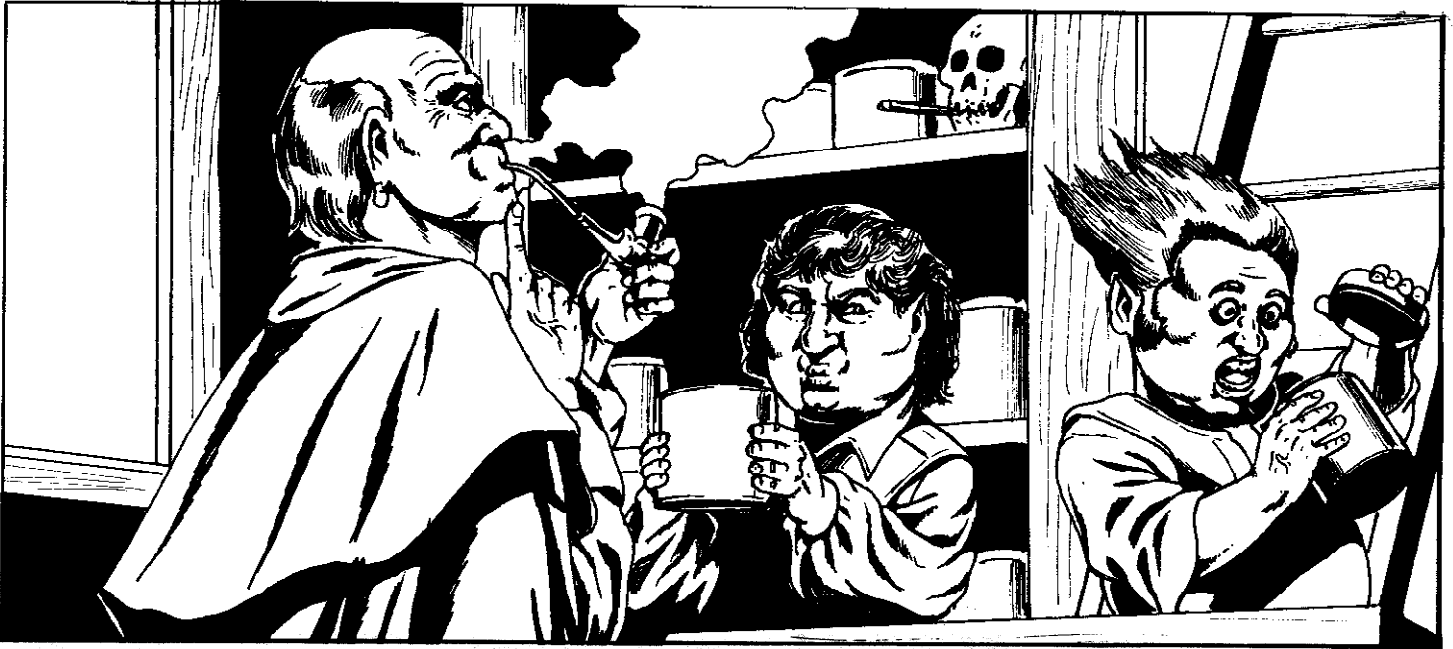

enough for 15-20 pipefulls.

A specially ordered leaf takes from one week to two months to arrive, although Oscar can get most types rather quickly if he is offered enough money. A custom pipe, on the other hand, can take quite long to finish. If Oscar is diligent about his carving, he can have one ready in about five weeks. If however, the pipe is especially detailed and Oscar is often distracted by trips out of town, he can take up to eight months to finish the pipe.

Oscar Sodhome

5th Level Halfling Thief

STR: 15
INT: 11
WIS: 12
DEX: 18
CON: 13
CHA: 11
AC Normal: 6 (4 with armor)
AC Rear: 10 (8 with armor)
Hit Points: 20
Alignment: Neutral Evil
Languages: Common, Thieves' Cant, Halfling, Dwarvish, Goblin

Weapon Proficiencies: Short sword, dagger, club

Non Weapon Proficiencies: Artistic ability, pipe carving (13), appraising (12)

Magic Items: *Cloak of displacement, boots of elvenkind*

Thief Skills:

| PP | OL | FT | MS | HS | DN | CW | RL |
|----|----|----|----|----|----|----|----|
| 30 | 80 | 60 | 45 | 65 | 35 | 45 | - |

Backstab for triple damage

Appearance: Oscar is a common-looking halfling with brown, curly hair and curious, blue eyes; he is 67 years old, weighs 64 pounds, and stands three feet tall. He is very active and must always be doing something; he finds little use in just sitting and thinking. Oscar is very secretive and tells others almost nothing about himself. When he talks, it is usually about the weather or pipes.

Background: Money has a serious hold on Oscar because with it he can purchase gems, which he loves dearly. He has a secret compartment under the couch in his room (see below) where he keeps a trove of gems.

Oscar leaves town quite often. He tells Chug that he goes to search for the secret root for his custom pipes. Since he always comes back with a small sack of the cherished root, Chug never questions Oscar's honesty. Actually Oscar goes on these trips because he is a burglar for hire. Over the years Oscar has established many contacts among the ruling class, and his thieving for them is his major source of income. His employers contact him through servants who come to Leaf in

Root and post notices asking for the services of a thief; the notices are signed with a two-letter code (which looks like initials) identifying the noble who requires Oscar's services. The code assures the employer's anonymity when Chug and others read the publicly-posted notices. Upon seeing one of these notices, Oscar leaves within a day to meet the noble and learn of his task. He has never been caught on any of his assignments and has almost always been successful. For his services, Oscar is paid in gold or gems (he prefers the latter), and he also receives a bag full of the finest briar root pieces available. It is from these pieces that Oscar makes his "secret" root. To make the root seem different from regular briar, Oscar soaks it in ale for three days, then scorches it in a hot fire. This not only conceals the true material of the root, but Oscar insists that it makes the pipe tastemuch better. Nevertheless, by doctoring briar and then selling it later for a high price, Oscar does quite well for himself.

Chug Millman

1st Level Halfling Fighter

STR: 14
INT: 8
WIS: 12
DEX: 12
CON: 11
CHA: 12

Inside Ravens Bluff

Leaf In Root Ground Floor

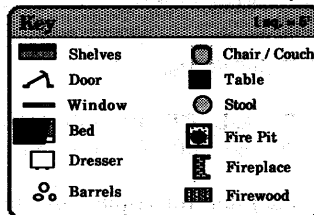
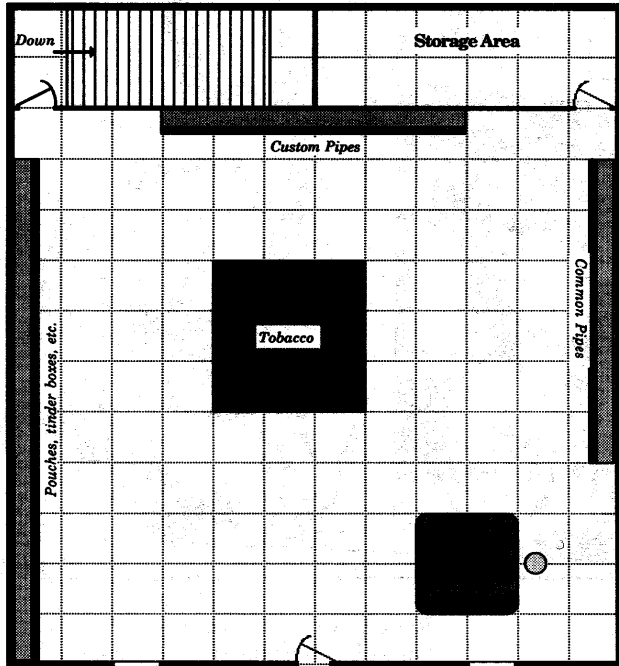

Leaf In Root Lower Floor

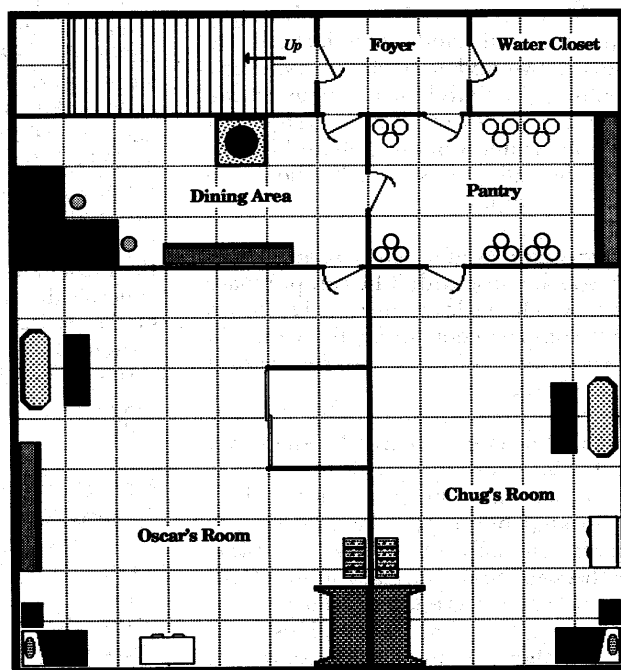

AC Normal: 10
 AC Rear: 10
 Hit Points: 6
 Alignment: Neutral
 Languages: Common, Halfling

Weapon Proficiencies: Short sword, dagger, club, hand axe
Non Weapon Proficiencies: Endurance (12)
Magic Items: *Dagger +1*

Appearance: Chug is tall for a halfling, at 3'8". He weighs 72 pounds. He is 40 years old and has light brown hair and brown eyes. Chug's real name is Willy; he got his nickname from some friends who were amazed at his ability to drink large quantities of ale very quickly. Chug is famous in nearby bars for his talent with a mug of potent ale.

Background: As a youngster, Chug was sure that he wanted to be an adventuring fighter. However, after a small success, and more failures, Chug decided that adventuring was not for him; he prefers to tell and hear stories of great fighters. Chug also has a good-sized collection of shields in his room, and he is always on the lookout for fine shields. He has no preference as to size or style; he only demands that the shield look battle-worn, and he loves it if the owner can recount the ways in which the shield was damaged.

Chug usually keeps quiet about his drinking ability and his shield collection. He will rarely talk of himself, although this is because he is fairly shy, not because he is secretive like Oscar. Chug is also a pessimist and often declares (after he has had some ale) that the world is in decline and that there are no great heroes left.

Chug and Oscar have a relationship of mutual respect, although they do not particularly like one another. Chug feels that he owes Oscar since Oscar gave him a job (Oscar, however, is quite pleased that he found the unquestioning, reliable Chug).

Leaf in Root Layout

The Store: Windows in the wall facing the street augment the light provided by several lanterns hung about the room. Customers usually find Oscar or Chug (the two are rarely in the shop at the same time) sitting on a stool at the table near the front door. Hiring notices are posted on the wall, to the left of the door as the customers enter. Customers are not

Inside Ravens Bluff

allowed beyond this room.

Storage: The area holds supplies of tobacco, pipes, lantern oil, and money for change. A locked chest holds 100 gp, 100 sp, 100 cp, and 10 pp.

Stairway: The door leading to the stairs always is kept locked. Both Oscar and Chug have keys.

Foyer: This room is empty.

Water Closet: This has the usual fixtures. A vent allows odors to escape to the street above.

Pantry: This cool room has barrels of pickles and ale and shelves holding all sorts of food including cakes, crackers, coffee, and cookies.

Dining Area: This is furnished with an old wooden table complemented by two fine, wooden stools. There are also shelves and a fire pit. Upon the shelves are various eating utensils, plates, and mugs. The firepit is used for warmth and cooking. Here is where the halflings eat and where Oscar carves pipes.

Oscar's Room: This neatly tidied room has a bed, a fireplace, firewood, a couch, a closet, and a bookshelf. The books on the bookshelf deal with herbs, tobaccos, pipes, and gems; they are written in Dwarvish. Beneath the couch is a secret door which opens to a 3'x3'x3' space containing Oscar's chest of gems. There are six fancy stones, three gem stones, one jewel, and ten semi-precious stones; DMs should determine particular types of stones as they see fit. Behind Oscar's bed is a shifting panel which reveals the hiding place for his magic items and thieves' tools and weapons. The closet has a concealed door, behind the clothes, which also opens to a 3-foot cubical space. This houses Oscar's special briar roots and his pipe carving instruments. Also here is a small coffer which holds 55 pp and 30 gp. Oscar keeps an urn on the mantelpiece which holds another 105 gp, although one must look inside the urn to see the gold.

Chug's Room: Though the room is otherwise very messy, Chug's shield collection is hung along neatly the walls. There are seventeen shields hung in orderly fashion. There also is a bed, a fireplace, a pile of firewood, a couch, and a chest of

drawers. In the top drawer of the chest is a pouch with 38 gp and 23 sp. On top of the chest is Chug's pipe. Beneath his bed there is a short sword on the floor and his magical dagger under a loose stone.

Living City Writers Guidelines

Ravens Bluff and the land around it rests in the capable and creative hands of members of the RPGA™ Network. The city will grow and evolve so long as members provide the material.

If you want to send a submission to The Living City, read the following guidelines. Only material from RPGA Network members will be considered for publication. An RPGA Network membership form appears at the end of this product.

Content

Ravens Bluff is part of the FORGOTTEN REALMS™ campaign setting, a supplement to the AD&D® 2nd Edition game. Because of that, all characters included in submissions must have AD&D game statistics. These statistics should include all character attribute scores – Strength, Intelligence, Wisdom, Dexterity, Constitution, and Charisma. The character's hit points, normal Armor Class, rear Armor Class, Weapon Proficiencies, Nonweapon Proficiencies, Languages, and Spells and Thieving abilities – if applicable – also should be included. Read the characters presented in this pack and in Living City features in the POLYHEDRON™ Newszine for examples. Characters also should have backgrounds, detailed personalities, motivations, and notes on how they relate to PCs they will encounter in campaigns.

Businesses and their owners/operators are among the most popular Living City features appearing in the POLYHEDRON Newszine. Each submission should include the name of the building, what the business involves, a drawing of the building's layout, and complete game statistics, background, motivations, and personalities for the owners and/or operators. If the business is a shop, include the type of merchandise that is sold, the quality, and the kind of customers who purchase the merchandise.

Mini-adventures such as *Party on Embassy Row* in this product, should include a DM summary of the adventure and should list the player character levels the adventure is intended for.

NPCs, creatures, or tricks/traps and other situations must be fully explained and include all appropriate statistics. For example, if you choose to create an encounter with a thief, you need to list all the thief's abilities, his items carried, and his plan involving the PCs.

New monsters and magic items are welcome, just as long as they are fully detailed. New creatures must be detailed with AD&D game statistics. List these statistics as they appear in the *Monstrous Compendiums*.

The Basics

All submissions must be typed and double-spaced on 8 1/2" by 11" white paper. Computer printouts are acceptable if the printing is dark enough to be easily read. Be sure to leave a one-inch minimum margin around all four sides of your text.

On the first page of your submission put your name, address, telephone number, and Network membership number. If you wish to use a pen name on your article, include it after the title of the article. On each following page put your name, a short form of the title, and the page number.

Make sure you keep the original or a photocopy of each submission for your records.

Each submission must be accompanied by a standard disclosure form. A disclosure form appears at the end of these submission guidelines.

The RPGA Network does not pay for Living City submissions. However, authors of material accepted for publication will receive gift certificates to the Mail Order Hobby Shop and will have the gratification of seeing their work in print.

Ethics

All submissions to Ravens Bluff, The Living City must be in good taste and of high quality. It is important that you follow these principles: *Never portray evil in an attractive light.* Evil characters should be portrayed as foes. *Do not give explicit details and methods of crime, violence, magic, or gore.* A good writer can imply situations with-

Inside Ravens Bluff

out graphically detailing them. *Crime should not be romanticized.* Don't present crime in a way that might inspire others to imitate criminals. *Drug and alcohol abuse can only be presented as dangerous habits.* Substance abuse is unattractive and should be portrayed that way. *Guards, constables, and other civil officials should not be depicted in such a way as to cause readers to disrespect real-life agents of the law.*

Slang and colloquialisms are all right to use in dialogue. However, excessive use is discouraged, and it is not recommended in descriptive passages. *Profanity, obscenities, and vulgarity are not acceptable. Lust and sexual perversion should not be portrayed or implied in submissions.*

Current religions should not be depicted, ridiculed, or attacked. Ancient or mythological religions can be portrayed in compliance with the other ethical considerations presented in these guidelines.

Standard Disclosure Form

I wish to submit the following materials for your consideration for publication by the RPGA™ Network, subject to all of the conditions below.

Working title of submission and brief description (please print):

I submit my materials voluntarily and on a non-confidential basis. I understand that this submission by me and its review by TSR, Inc. ("TSR") does not, in whole or in part, establish or create by implication or otherwise any relationship between TSR and me that is not expressed herein. I further understand and agree that TSR, in its own judgment, may accept or reject the materials that are submitted with respect to my submission until TSR shall, at its own election, enter into a properly executed written agreement with me, and then only according to the terms of such an agreement.

I agree that TSR may have a reasonable period of time in which to review this submission. TSR will return my submission to me provided it is received by TSR with a self addressed stamped envelope. TSR shall not be held responsible, however, for items or materials that are accidentally damaged or lost. I hereby agree to retain a copy of the submitted materials.

I understand and agree that the review by TSR of the materials that accompany this disclosure form does not imply or create (1) any financial or other obligation of any kind on the part of TSR, (2) any confidential relationship or guarantee of secrecy, or

(3) any recognition or acknowledgment of either novelty or originality.

I also understand and agree that if the submission utilizes or is based on characters, settings, or other materials that are owned by TSR or if the submission contains trademarks and/or other proprietary materials that are owned by TSR, then I shall not be free to submit the submission for publication to any person or firm other than TSR.

I warrant that the submission (has never been published) (has been published by _____

in _____) that it is original, and that its publication will not violate the rights of any third party. I also warrant that I am the sole owner of the submission. Furthermore, I am of legal age and am free to make agreements relative to this submission or I am the authorized representative of the submitter (circle one: Parent, Legal Guardian,

Agent, Other: _____) who is the owner of the submission.

Signature: _____

Please type or print the following:

Submitter's Name _____

Date _____ Phone _____

Address _____



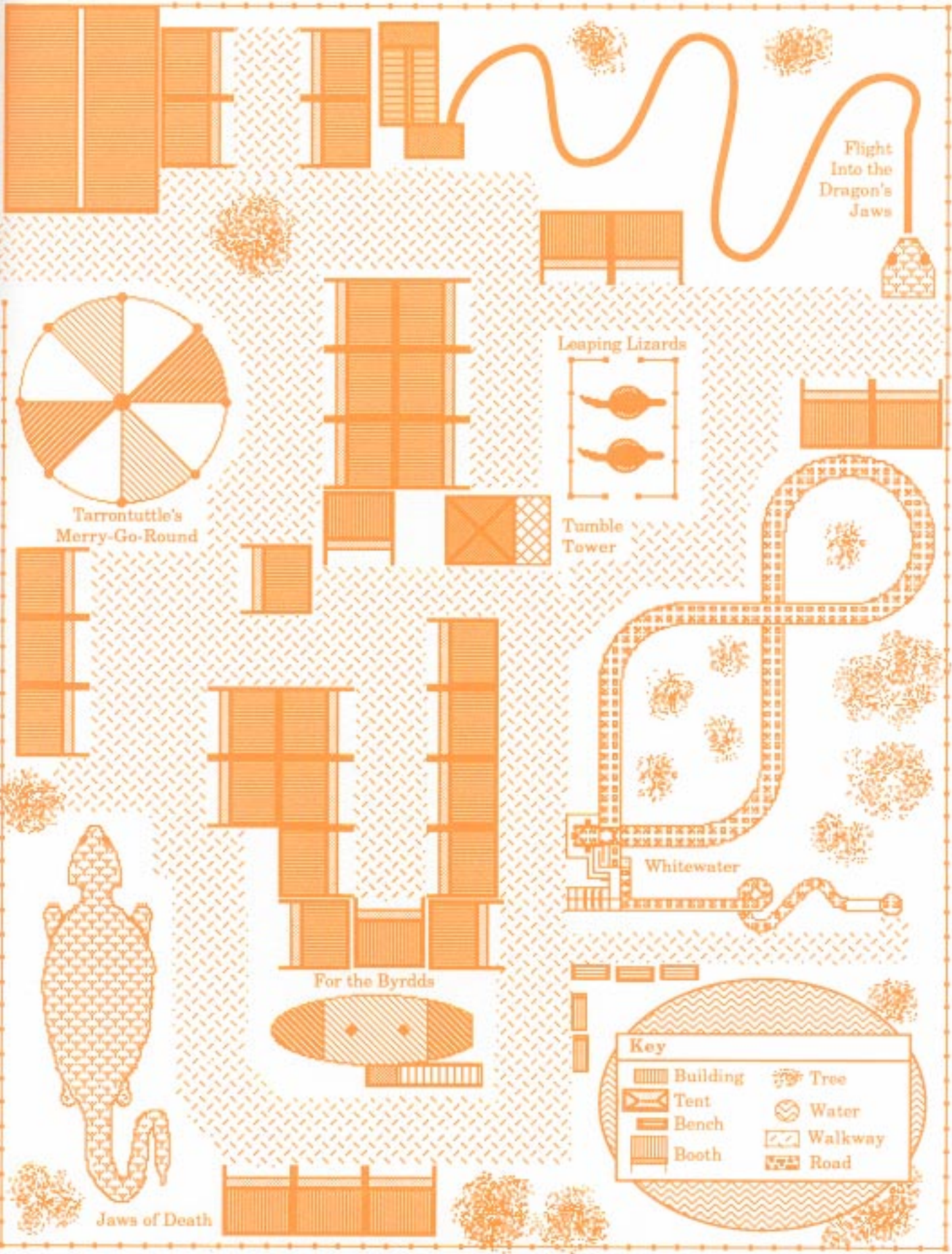

Flight
Into the
Dragon's
Jaws

Tarrantuttle's
Merry-Go-Round

Leaping Lizards

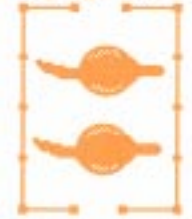

Tumble
Tower

Whitewater

For the Byrds

Jaws of Death

Key

- | | | | |
|--|----------|--|---------|
| | Building | | Tree |
| | Tent | | Water |
| | Bench | | Walkway |
| | Booth | | Road |

Advanced Dungeons & Dragons
2nd Edition



INSIDE RAVENS BLUFF, THE LIVING CITY

Continue your tour of the Ravens Bluff™ campaign setting, the brightest spot on the Dragon Reach. Meet Jack Mooney, proprietor, manager, and ringmaster of the Realms' largest traveling circus. Lucky visitors receive invitations to our *Party on Embassy Row*, where intrigue and high society collide. Visit Lord Mayor Charles Oliver O'Kane's study for a quick peek at Elminster's notes on Ravens Bluff and environs. Discover more new businesses, personalities, and officials—including the Vulture, the city's infamous tax collector. All stops on your tour will add adventure to your travels in the FORGOTTEN REALMS™ campaign setting.

TSR, Inc.
POB 756
Lake Geneva,
WI 53147 USA



TSR Ltd.
120 Church End, Cherry Hinton
Cambridge CB1 3LB
United Kingdom

ISBN 1-56076-048-6

